



**BOARD OF SUPERVISORS AGENDA ITEM REPORT**

Requested Board Meeting Date: February 21, 2017

**Title:** Final Plat (P16FP00010) Rancho Del Lago, Block 27, Lots 1-42 & Common Areas "A", "B", "C-1" & "C-2".

**Introduction/Background:**

Final Plat process to create a legally subdivided property.

**Discussion:**

N/A

**Conclusion:**

N/A

**Recommendation:**

Staff recommends approval.

**Fiscal Impact:**

N/A

**Board of Supervisor District:**

1       2       3       4       5       All

---

Department: Development Services

Telephone: 724-6490

Department Director Signature/Date:

*Colin S. Blackwell*

Jan 31, 2017

Deputy County Administrator Signature/Date:

*[Signature]*

1/30/17

County Administrator Signature/Date:

*C. DeLuca*

2/1/17

---

## Location Map

- ① SEQ #20162940427
- ② SEQ #20112850077
- ③ SEQ #20162940450

**THIS  
PROJECT**



SCALE: 3" = 1 MILE

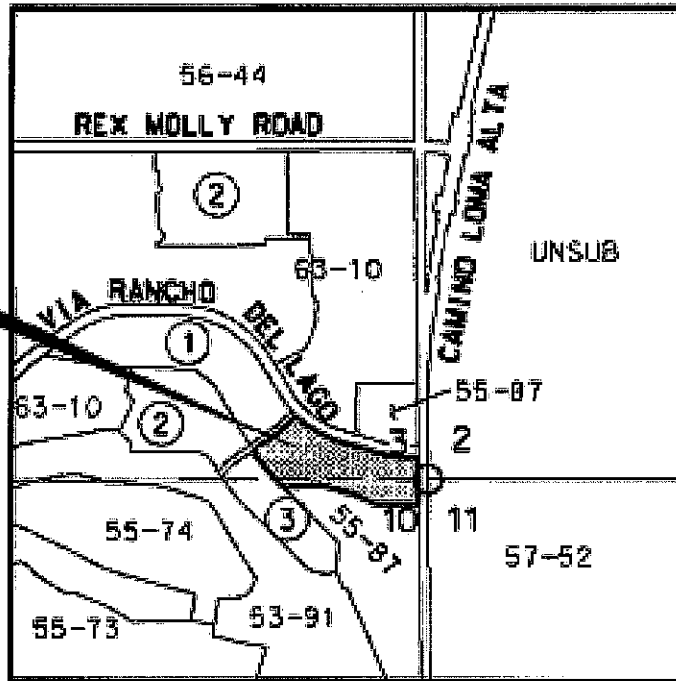

## **LOCATION MAP**

SECTIONS 3 & 10, T 16 S, R 16 E  
G & SRM  
PIMA COUNTY, ARIZONA

Final Plat

P16FP00010

Rancho Del Lago

Block 27

Lots 1-42 & Common Areas

“A”, “B”, C-1” & “C-2”

**ASSURANCE AGREEMENT FOR CONSTRUCTION OF  
SUBDIVISION IMPROVEMENTS (Third Party Trust)**  
[P16FP00010]

THIS AGREEMENT is made and entered into by and between VAIL VALLEY JOINT VENTURE, an Arizona General Partnership or successors in interest ("Subdivider"), FIDELITY NATIONAL TITLE AGENCY, INC., an Arizona corporation ("Trustee"), as trustee under Trust No. 10,756; and Pima County, Arizona ("County").

**1. RECITALS**

1.1. Subdivider is the beneficiary and Trustee is the trustee of a trust which owns land ("the Land") located in Pima County, Arizona and described in paragraph 2.1 of this agreement.

1.2. County, Subdivider and Trustee wish to establish specific terms, conditions, and guidelines relating to the subdivision of the Land and construction of related improvements to comply with A.R.S. § 11-821.

**2. AGREEMENT**

Based on the foregoing recitals, which are incorporated here as the intent of the parties, and in consideration of County's approval of a final plat for the Land, County, Subdivider and Trustee agree as follows:

2.1. *Property Description.* The Land is all of the real property which is the subject of the subdivision plat ("the Subdivision Plat") identified as Lots 1-42 & Common Areas "A", "B" & "C-1" - "C-2" OF, RANCHO DEL LAGO BLOCK 27 recorded in Sequence number \_\_\_\_\_ on the \_\_\_\_\_ day of \_\_\_\_\_, 20\_\_\_\_, in the Office of the Pima County Recorder.

2.2. *Construction of Subdivision Improvements.* As a condition of subdivision approval, Subdivider hereby agrees to construct all subdivision improvements ("the Subdivision Improvements") contemplated by the Subdivision Plat, rezoning conditions, and any associated site construction permits, including but not limited to onsite and offsite streets, sanitary sewers (if necessary), water and electric utilities, drainage and flood control improvements, parks, trails or other recreational facilities, other required infrastructure, and riparian habitat mitigation or payment of the riparian habitat mitigation in-lieu fee.

2.3. *Existing Utilities.* Any relocation or modification of existing utilities or public improvements required in order to construct the Subdivision Improvements shall be done at no expense to the public. Subdividers performance of this requirement shall be considered in determining whether to release assurances under paragraphs 2.5 and 2.6.

2.4. *Assurance of Construction.* This agreement is submitted as an assurance that Subdivider will construct the Subdivision Improvements, as required by A.R.S. § 11-821 and Pima County Zoning Code Chapter 18.69.

2.5. *Limitation on Transfer of Title.* Trustee shall not convey title to any of the Land without obtaining prior written approval from County in the form of a Release of Assurance. A Release of Assurance shall not be provided by County until the Subdivision Improvements are completed in accordance with paragraph 2.12.

2.6. *Partial Release of Assurances.* County shall issue a Release of Assurance for some of the lots depicted on the Subdivision Plat if all of the following have occurred:

A. All of the Subdivision Improvements required in connection with the released lots have been completed in accordance with paragraph 2.12, and

B. County finds that the released lots and the Subdivision Improvements required in connection with them can be used and maintained separately from the Subdivision Improvements not yet completed in accordance with paragraph 2.12, and

C. Recreation area in-lieu fee, if applicable, has been paid to the county for the entire subdivision, prior to a release of greater than 75% of total subdivision lots.

2.7. *Deposit Receipt Agreements.* Notwithstanding paragraph 2.5, Trustee may enter into a deposit receipt agreement for the sale of the Land or any portion of it if the agreement clearly states that no portion of the Land shall be conveyed until Subdivider performs its obligations under this agreement.

2.8. *Bulk Sales.* Notwithstanding paragraph 2.5, Trustee may sell and convey all of the Land in one transaction to a single purchaser who has entered into a satisfactory assurance agreement with County, assuring completion of the Subdivision Improvements.

2.9. *Conveyance Out of Trust for the Purpose of Encumbrance.* Notwithstanding paragraph 2.5, Trustee may convey all or part of the Land to the Subdivider for the sole purpose of encumbering the Land by the recording of mortgages or deeds of trust, provided that the Land is thereafter immediately reconveyed into the trust.

2.10. *Real Property Taxes.* All real property taxes on the Land shall be paid before the taxes are delinquent as defined by A.R.S. 42-18052(B). If the real property taxes on the Land, including any lot or portion of common area, become delinquent, this agreement will be in default.

2.11. *Substitution of Assurances.* Subdivider may submit substitute assurances in a form and amount acceptable to County at any time during which this agreement is not in default.

2.12. *Completion of the Subdivision Improvements.* The Subdivision Improvements shall be completed by Subdivider not more than four years after the date of this agreement. The Subdivision Improvements shall not be considered completed until after they have been constructed in accordance with the Subdivision Plat, rezoning conditions, associated site construction permits, and after County has inspected them and finds them to be in compliance with the plans.

2.13. *Acceptance of the Subdivision Improvements.* County shall not accept maintenance responsibility for any of the Subdivision Improvements unless and until all of the following have occurred:

A. They have been completed in accordance with paragraph 2.12.

B. They have been dedicated to County by the Subdivision Plat or by some other instrument of record.

C. The dedication has been accepted by the Pima County Board of Supervisors as evidenced by approval of the dedication on the Subdivision Plat or by some other formal action.

2.14. *Default, Non-Compliance; County's Options.* This agreement is in default if either the Subdivider or Trustee fails to comply with obligations under this agreement. If this agreement is in default, the County may exercise any or all options below at its sole discretion:

A. The County may re-plat all or a portion of the Land for the purpose of returning the portions of Land which are the subject of the re-plat to approximately the same boundary configurations of record which existed before the recording of the Subdivision Plat. The Subdivider authorizes the County to execute, on behalf of Subdivider, the re-plat described in this section. The re-plat may exclude any dedications to the public which were made on the Subdivision Plat which are necessary to serve either portions of the Land which are not re-platted, or to serve the public. Subdivider shall pay the reasonable costs incurred in re-platting. Notice of default and intent to re-plat will be sent to the last known address of Subdivider and Trustee by certified mail not less than thirty days before County exercises its option to re-plat under this paragraph.

B. If site conditions change after the Subdivider fails to comply with this agreement, the County may require that Subdivider submit evidence that the Tentative and Final Plat comply with current regulations, under current site conditions. If the County determines that the Tentative Plat or Final Plat does not comply, Subdivider shall submit revisions to the plat, to the County with applicable fees. If the revisions are approved by the Board of Supervisors, the date specified in Section 2.12 of this agreement may be extended by up to four years from the approval date. This subsection is not applicable to Block Plats for master planned communities.

C. The County may withhold the issuance of permits for building regulated by Title 15 of the Pima County Code or work regulated by Title 18 of the Pima County Code.

2.15. *Incorporation and Annexation.* If the Land is incorporated as or annexed by a city or town, the city or town shall automatically succeed to all benefits and duties of County under this agreement.

2.16. *Termination.* This agreement shall remain in full force and effect until one of the following has occurred:

A. The Subdivision Improvements have been completed and approved by County in accordance with paragraph 2.11 and a Release of Assurances with respect to all the Land has been recorded in the Office of the Pima County Recorder in accordance with paragraph 2.5; or

B. A new subdivision plat has been recorded for the Land in compliance with any and all applicable laws and regulations; or

C. A substitute assurance agreement has been executed by and between Subdivider and County in accordance with paragraph 2.11.

2.17. *Effective Date.* This Agreement is effective on the \_\_\_\_\_ day of \_\_\_\_\_, 20\_\_\_\_, which is the date of approval of this agreement by the Pima County Board of Supervisors.

PIMA COUNTY, ARIZONA

SUBDIVIDER: VAIL VALLEY JOINT VENTURE, an Arizona joint venture partnership

By: Mandell Vail Corp., an Illinois corporation, as Partner

\_\_\_\_\_  
Chair, Board of Supervisors

By: Sheldon J. Mandell

Its: President

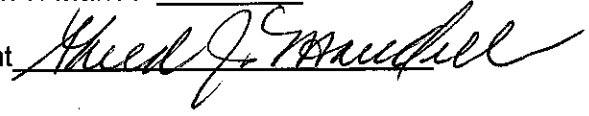

ATTEST:

TRUSTEE: FIDELITY NATIONAL TITLE AGENCY, INC., an Arizona corporation, as Trustee under Trust No 10,756, and not in its corporate capacity

\_\_\_\_\_  
Clerk of the Board

By: Martha L Hill

Its: Trust Officer

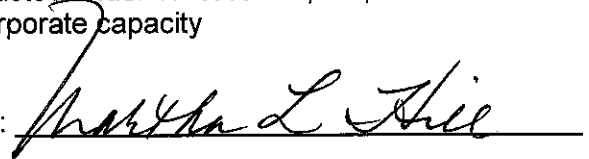

STATE OF ~~ARIZONA~~ Illinois  
County of ~~Pima~~ Cook )

The foregoing instrument was acknowledged before me this 29<sup>th</sup> day of November, 2016, by Sheldon J. Mandell as President of Mandell Vail corp., an Illinois corporation as Partner for Vail Valley Joint Venture, an Arizona joint venture partnership ("Subdivider"), on behalf of the partnership.

\_\_\_\_\_  
Notary Public

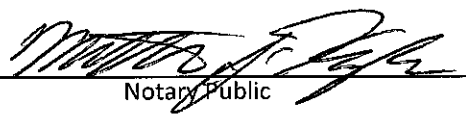

My Commission Expires:  
\_\_\_\_\_



STATE OF ARIZONA )  
County of Pima )

The foregoing instrument was acknowledged before me this 5<sup>th</sup> day of December, 2016, by Martha L. Hill of Fidelity National Title Agency, Inc., an Arizona corporation ("Trustee"), on behalf of the corporation as trustee under trust number 10,756.

\_\_\_\_\_  
Notary Public

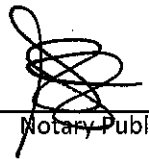

My Commission Expires \_\_\_\_\_

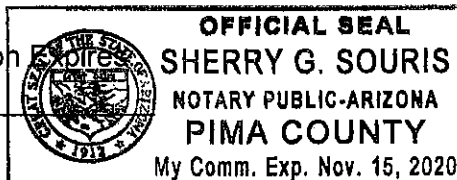



**GENERAL NOTES**

1. THE TOTAL MILES OF NEW PRIVATE STREETS IS 0.22.
2. THE GROSS AREA OF THIS SUBDIVISION IS 11.28 ACRES.
3. THE TOTAL NUMBER OF LOTS IS 42.
4. THIS SUBDIVISION LIES WITHIN AN AREA DESIGNATED AS HAVING AN ASSURED WATER SUPPLY.
5. THE BASIS OF BEARING FOR THIS SUBDIVISION IS THE NORTH LINE OF THE SOUTHEAST QUARTER OF SECTION 3, TOWNSHIP 16 SOUTH RANGE 16 EAST, GILA AND SALT RIVER MERIDIAN, PIMA COUNTY, ARIZONA, AS MONUMENTED BY A BRASS DISC AT THE EAST ONE QUARTER CORNER OF SAID SECTION 3 AND BY A HALF INCH REBAR AT THE CENTER-WEST 1/16TH CORNER BEING ALSO THE NORTHWEST CORNER OF BLOCK 25 OF RANCHO DEL LAGO SUBDIVISION, RECORDED IN BOOK 55 OF MAPS AND PLATS AT PAGE 87; SAID BEARING BEING: SOUTH 89°30'12" WEST.
6. INTERIOR PROPERTY CORNERS SHALL BE MONUMENTED AS SOON AS COMPLETION OF THE INFRASTRUCTURE AND IMPROVEMENTS MAKE IT PRACTICAL TO DO SO. IF SUCH MONUMENTS SHOULD DIFFER FROM THE TYPE DESCRIBED ON THE FINAL PLAT, A RECORD OF SURVEY SHALL BE FILED SHOWING THOSE DIFFERENCES. ALL MONUMENTS SET SHALL BE UNDER THE DIRECT SUPERVISION OF THE SURVEYOR OF RECORD. IF FOR ANY REASON THE SURVEYOR OF RECORD IS NOT AVAILABLE TO SUPERVISE THE SETTING OF THE INTERIOR CORNER MONUMENTS, SUBSEQUENT TO THE RECORDING OF THE FINAL PLAT, THE REPLACEMENT SURVEYOR SHALL SET MONUMENTS WITH HIS/HER IDENTIFYING NUMBER AND A RECORD OF SURVEY SHALL BE RECORDED IN ACCORDANCE WITH AZ STATE STATUTES.
7. CROSS ACCESS PROVIDED ON SANDY LAKE DRIVE PER ACCESS EASEMENT AGREEMENT RECORDED AT SEQ. #20162980509.

**PERMITTING NOTES**

1. CONDITIONALLY APPROVED ZONING IS SPECIFIC PLAN (SP).
2. DEVELOPMENT STANDARDS FOR MDR:
  - AVERAGE LOT AREA/UNIT: 6,000 SF
  - MAX LOT COVERAGE: 50% (60% FOR SINGLE STORY)
  - MAX BUILDING HT: 30'
  - INDIVIDUAL LOT SETBACKS:
    - FRONT: 20'; OR 10' WITH SIDE OR REAR ENTRY GARAGE
    - SIDE: 10' (TOTAL COMBINED)
    - REAR: 10'; OR 0' WITH REAR ENTRY GARAGE
3. THIS SUBDIVISION IS SUBJECT TO BOARD OF SUPERVISORS VAIL VALLEY RANCH SPECIFIC PLAN CONDITIONS FOUND IN ORDINANCE 1989-130 (CASE NUMBER C023-89-01) AS APPROVED ON SEPTEMBER 12, 1989 AND ORDINANCE 1998-14 (FIRST AMENDED BY CASE NUMBER C023-97-01) AS APPROVED ON FEBRUARY 3, 1998 AND AUGUST 15, 2005 (SECOND AMENDMENT)
4. GROSS DENSITY IS 3.7 RAC.
5. GARAGES SHALL BE SETBACK A MINIMUM OF 20 FEET FROM THE RIGHT-OF-WAY.
6. MATERIALS WITHIN THE SIGHT VISIBILITY TRIANGLE EASEMENT SHALL BE PLACED SO AS NOT TO INTERFERE WITH A VISIBILITY PLANE DESCRIBED BY TWO HORIZONTAL LINES LOCATED 30 INCHES AND 72 INCHES ABOVE FINISHED FLOOR GRADE OF THE ROADWAY SURFACE.
7. THIS SUBDIVISION IS SUBJECT TO THE APPROVED NATIVE PLANT PRESERVATION AND LANDSCAPE PLANS.

**DEDICATION**

I, THE UNDERSIGNED, HEREBY WARRANT THAT I AM THE ONLY PARTY HAVING ANY TITLE INTEREST IN THE LAND SHOWN ON THE PLAT, AND I CONSENT TO THE SUBDIVISION OF SAID LAND IN THE MANNER SHOWN HEREON.

I, THE UNDERSIGNED, HEREBY GRANT TO PIMA COUNTY AND ALL UTILITY COMPANIES ALL PUBLIC EASEMENTS AS SHOWN HEREON FOR THE PURPOSE OF ACCESS, INSTALLATION AND MAINTENANCE OF PUBLIC SEWERS, UTILITIES, AND OTHER USES AS DESIGNATED BY THIS PLAT.

I, THE UNDERSIGNED, DO HEREBY HOLD HARMLESS PIMA COUNTY AND PIMA COUNTY REGIONAL FLOOD CONTROL DISTRICT, THEIR SUCCESSORS, ASSIGNS, EMPLOYEES, OFFICERS, AND AGENTS FROM ANY AND ALL CLAIMS FOR DAMAGES RELATED TO THE USE OF THE PROPERTY DEPICTED ON THIS PLAT NOW AND IN THE FUTURE BY REASONS OF FLOODING, FLOWAGE, EROSION, OR DAMAGE CAUSED BY WATER, WHETHER SURFACE FLOOD, OR RAINFALL.

COMMON AREAS AS SHOWN HEREON ARE RESERVED FOR THE PRIVATE USE AND CONVENIENCE OF ALL OWNERS OF PROPERTY WITHIN THE MASTER PLANNED COMMUNITY OF RANCHO DEL LAGO AND ARE GRANTED AS EASEMENTS TO PIMA COUNTY AND ALL UTILITY COMPANIES FOR ACCESS, INSTALLATION AND MAINTENANCE OF ABOVEGROUND AND UNDERGROUND UTILITIES AND PUBLIC SEWERS. TITLE TO THE LAND OF ALL COMMON AREAS SHALL BE VESTED IN RANCHO DEL LAGO COMMUNITY ASSOCIATION, AN ARIZONA NON-PROFIT CORPORATION (THE "MASTER ASSOCIATION"), AS ESTABLISHED BY THE AMENDED AND RESTATED MASTER DECLARATION OF COVENANTS, CONDITIONS AND RESTRICTIONS FOR RANCHO DEL LAGO RECORDED AS DOCKET 11645, PAGE 1221, AND BY THE ANNEXATION TO AMENDED AND RESTATED MASTER DECLARATION OF COVENANTS, CONDITIONS AND RESTRICTIONS AS RECORDED IN SEQ #2017. THE MASTER ASSOCIATION WILL ACCEPT THE RESPONSIBILITY FOR CONTROL, MAINTENANCE, AD VALOREM TAXES AND LIABILITY FOR ALL COMMON AREAS AND PRIVATE EASEMENTS THEREIN.

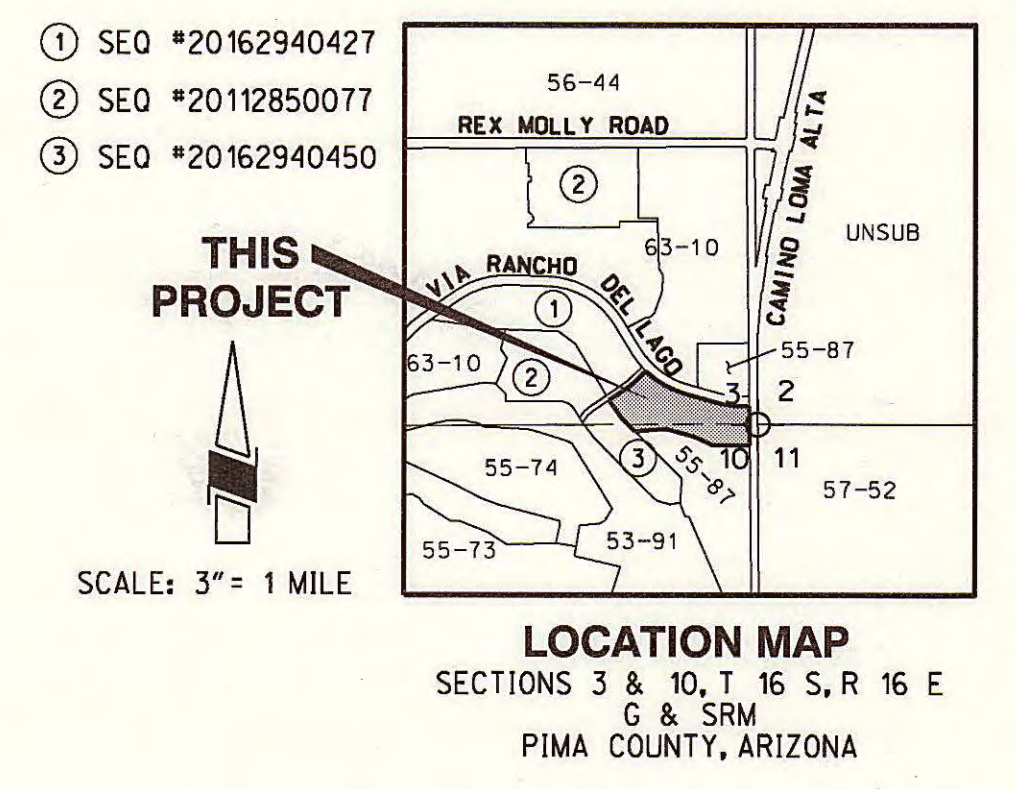
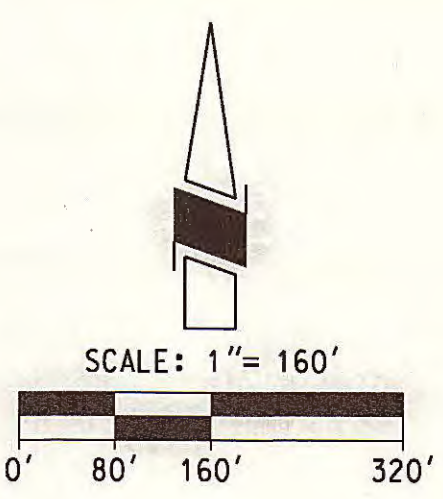
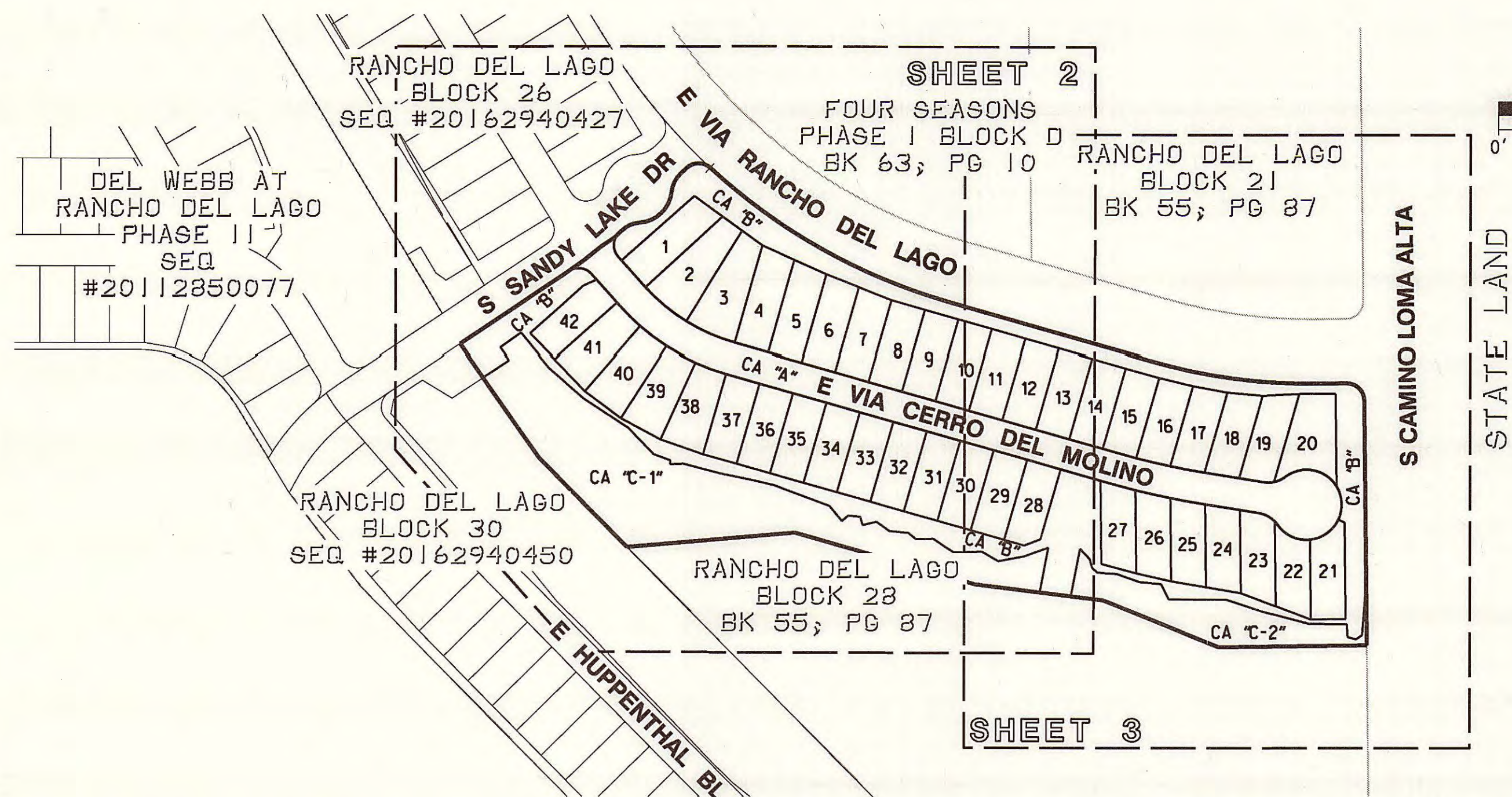

**DEDICATION CONTINUED**

FIDELITY NATIONAL TITLE AGENCY, INC., AN ARIZONA CORPORATION AS TRUSTEE UNDER TRUST NO. 10756, AS TRUSTEE ONLY AND NOT IN ITS CORPORATE CAPACITY.

BY: Martha L. Hill 1-31-17 DATE  
MARTHA L. HILL, TRUST OFFICER

**ACKNOWLEDGEMENT**

STATE OF ARIZONA } SS.  
COUNTY OF PIMA

THE FOREGOING INSTRUMENT WAS ACKNOWLEDGED BEFORE ME THIS 31<sup>ST</sup> DAY OF JANUARY 2017, BY MARTHA L. HILL OF FIDELITY NATIONAL TITLE AGENCY, INC., AN ARIZONA CORPORATION AS TRUSTEE UNDER TRUST NO. 10756, AS TRUSTEE ONLY AND NOT IN ITS CORPORATE CAPACITY.

Rita L. Kippes 5.9.18  
NOTARY PUBLIC MY COMMISSION EXPIRES



**ASSURANCES**

ASSURANCES IN THE FORM OF A THIRD PARTY TRUST AGREEMENT, TRUST NO. 10756 FROM FIDELITY NATIONAL TITLE AGENCY, INC., AN ARIZONA CORPORATION AS TRUSTEE UNDER TRUST NO. 10756, AS TRUSTEE ONLY AND NOT IN ITS CORPORATE CAPACITY, AS RECORDED IN SEQ #2017, HAS BEEN PROVIDED TO GUARANTEE IMPROVEMENTS AS REQUIRED BY THE PIMA COUNTY ZONING CODE, CHAPTER 18.69 (SUBDIVISION STANDARDS) IN THIS SUBDIVISION.

BY: \_\_\_\_\_ DATE  
CHAIR, BOARD OF SUPERVISORS PIMA COUNTY, ARIZONA

**ATTEST**

I, \_\_\_\_\_, CLERK OF THE BOARD OF SUPERVISORS, HEREBY CERTIFY THAT THIS PLAT WAS APPROVED BY THE BOARD OF SUPERVISORS OF PIMA COUNTY, ARIZONA, ON THIS \_\_\_\_\_ DAY OF \_\_\_\_\_, 2017.

\_\_\_\_\_  
CLERK, BOARD OF SUPERVISORS DATE

**RECORDING**

SEQ: #2017 \_\_\_\_\_  
FEE: \_\_\_\_\_  
STATE OF ARIZONA } SS.  
COUNTY OF PIMA

I HEREBY CERTIFY THAT THE INSTRUMENT WAS FILED FOR RECORD AT THE REQUEST OF RICK ENGINEERING COMPANY, INC.  
DATE \_\_\_\_\_  
TIME \_\_\_\_\_  
WITNESS MY HAND AND OFFICIAL SEAL DAY AND YEAR ABOVE WRITTEN  
F. ANN RODRIGUEZ, COUNTY RECORDER  
BY: \_\_\_\_\_ DEPUTY

**LEGEND**

SYMBOL	ITEM
⊕	FOUND BRASS DISC STAMPED, "RLS 17479"
⊙	FOUND BRASS DISC STAMPED, "RLS 14145"
○	SURVEY MONUMENT, RLS 17479 (1/2" REBAR WITH ID TAG OR AS NOTED)
●	LOT CORNER TO BE SET BY RLS FOLLOWING COMPLETION OF CONSTRUCTION (SEE GENERAL NOTE 5)
⊠	2" BRASS DISC IN CONCRETE TO BE STAMPED BY RLS FOLLOWING COMPLETION OF CONSTRUCTION
△	BOUNDARY CORNER
★	ACCESS SIDE (FOR ADDRESSING PURPOSES ONLY)
(RAD)	INDICATES BEARING IS RADIAL
SVT	SIGHT VISIBILITY TRIANGLE
23	LOT NUMBER
---	EXIST R/W
---	SECTION LINE
---	SUBDIVISION BOUNDARY
---	LOT LINE
---	CENTERLINE
---	EASEMENT BOUNDARY
--- BEHS ---	BUILDING EROSION HAZARD SETBACK LIMIT
--- XC ---	PROPOSED 100-YEAR REGULATORY FLOODPLAIN LIMIT
▨	XERORIPARIAN CLASS C HABITAT LIMITS
⬠	BUFFERYARD LIMITS
➔	FLOW ARROW FOR
Q <sub>100</sub> = 150 cfs	FLOW DISCHARGE Q <sub>100</sub> = DISCHARGE

**CERTIFICATION OF SURVEY**

I HEREBY CERTIFY THAT THIS PLAT REPRESENTS A SURVEY MADE BY ME OR UNDER MY SUPERVISION AND THAT ALL BOUNDARY MONUMENTS INDICATED HEREON ACTUALLY EXIST, AND THEIR LOCATION, SIZE AND MATERIAL ARE CORRECTLY SHOWN.

I HEREBY CERTIFY THAT THE FLOODPRONE LIMITS AND/OR EROSION HAZARD SETBACKS SHOWN ON THIS PLAT WERE PREPARED BY ME OR UNDER MY SUPERVISION.



**FINAL PLAT FOR RANCHO DEL LAGO BLOCK 27**

LOTS 1 - 42 & COMMON AREAS "A", "B" & "C-1 - C-2"

COMMON AREA "A": PRIVATE STREET, COMMON AREA "B": LANDSCAPE, DRAINAGE, UTILITIES, COMMON AREA "C": NATURAL OPEN SPACE, BEING A RESUBDIVISION OF BLOCK 27 OF RANCHO DEL LAGO, A SUBDIVISION OF PIMA COUNTY, ARIZONA, ACCORDING TO THE PLAT OF RECORD IN THE OFFICE OF THE COUNTY RECORDER IN BOOK 55 OF MAPS AND PLATS, PAGE 87 LYING WITHIN SECTION 3 & 10, TOWNSHIP 16 SOUTH, RANGE 16 EAST, GSRM

P16FP00010  
P16TP00011  
P1200-026  
C023-97-01  
C023-89-01  
C07-97-11



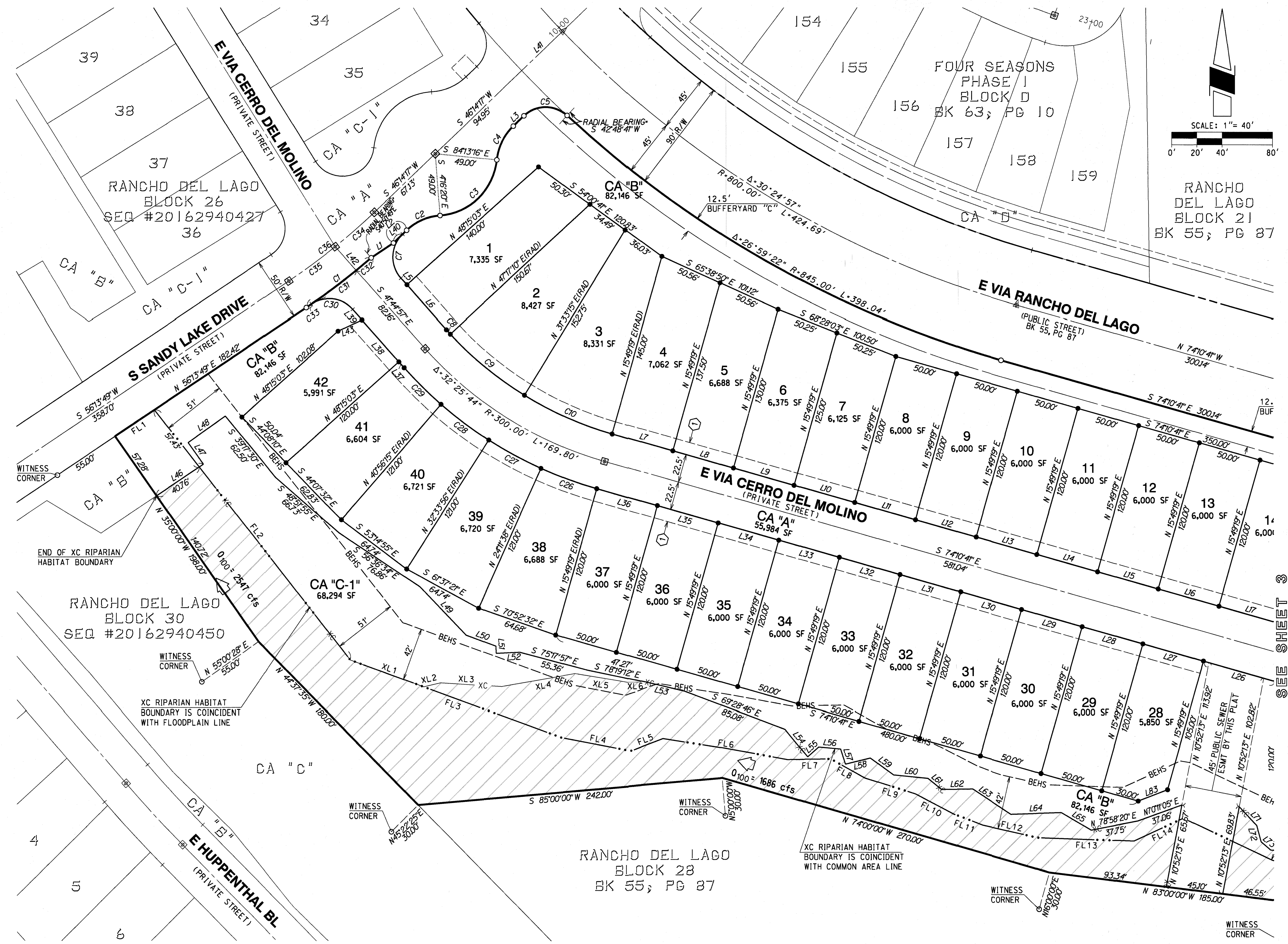
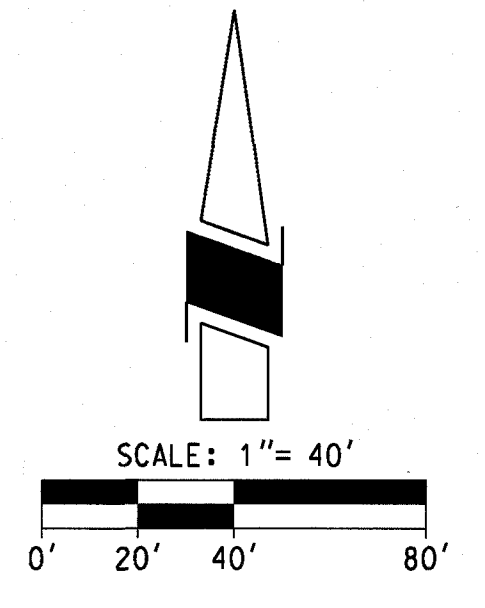

SEE SHEET 3

**FINAL PLAT FOR  
RANCHO DEL LAGO  
BLOCK 27**  
LOTS 1 - 42 & COMMON AREAS  
"A", "B" & "C-1 - C-2"

COMMON AREA "A": PRIVATE STREET, COMMON AREA "B": LANDSCAPE, DRAINAGE, UTILITIES, COMMON AREA "C": NATURAL OPEN SPACE, BEING A RESUBDIVISION OF BLOCK 27 OF RANCHO DEL LAGO, A SUBDIVISION OF PIMA COUNTY, ARIZONA, ACCORDING TO THE PLAT OF RECORD IN THE OFFICE OF THE COUNTY RECORDER IN BOOK 55 OF MAPS AND PLATS, PAGE 87 LYING WITHIN SECTION 3 & 10, TOWNSHIP 16 SOUTH, RANGE 16 EAST, GSRM

**KEYNOTES**

- 1. 10' PUBLIC UTILITY EASEMENT GRANTED TO PUBLIC UTILITY COMPANIES AND PIMA COUNTY BY THIS PLAT
- SEE SHEET 3 FOR LINE AND CURVE DATA TABLES

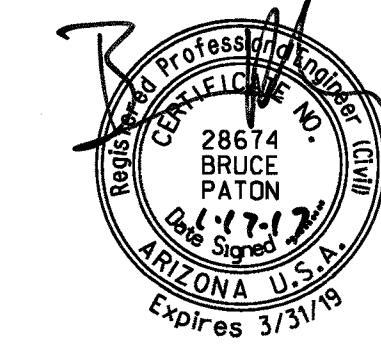
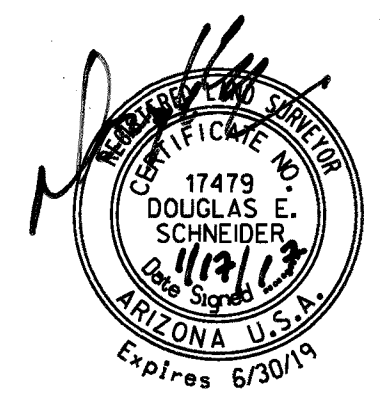

P16FP00010  
P16TP00011  
P1200-026  
C023-97-01  
C023-89-01  
C07-97-11

**RICK**  
ENGINEERING COMPANY  
3945 EAST FORT LOWELL ROAD - SUITE 111  
TUCSON, AZ 85712  
520-795-1000  
(FAX) 520-322-6956  
rickengineering.com  
J-4282  
San Diego - Riverside - Orange - Sacramento - San Luis Obispo - Phoenix - Denver



LINE DATA TABLE

Table with columns: NAME, DIRECTION, LENGTH. Lists line segments L1 through L83 with their respective bearings and lengths.

CURVE DATA TABLE

Table with columns: NAME, DELTA, RADIUS, ARC. Lists curve segments C1 through C36 with their respective delta angles, radii, and arc lengths.

RIPARIAN LINE TABLE

Table with columns: NAME, DIRECTION, LENGTH. Lists riparian line segments XL1 through XL10 with their respective bearings and lengths.

FLOOD LINE TABLE

Table with columns: NAME, DIRECTION, LENGTH. Lists flood line segments FL1 through FL23 with their respective bearings and lengths.

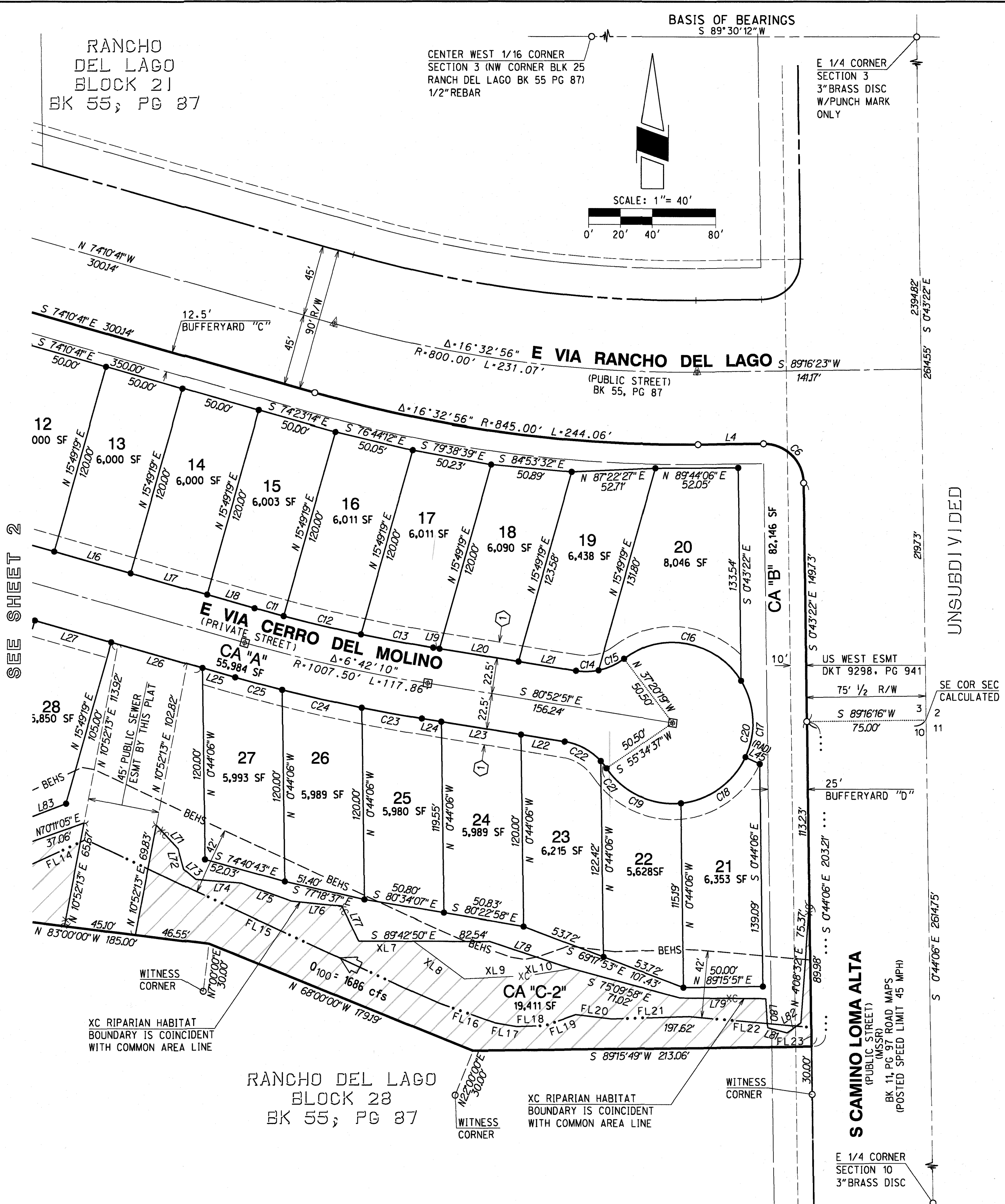

FINAL PLAT FOR RANCHO DEL LAGO BLOCK 27

P16FP00010
P16TP00011
P1200-026
C023-97-01
C023-89-01
C07-97-11

COMMON AREA "A": PRIVATE STREET, COMMON AREA "B": LANDSCAPE, DRAINAGE, UTILITIES, COMMON AREA "C": NATURAL OPEN SPACE, BEING A RESUBDIVISION OF BLOCK 27 OF RANCHO DEL LAGO...

KEYNOTES

10' PUBLIC UTILITY EASEMENT GRANTED TO PUBLIC UTILITY COMPANIES AND PIMA COUNTY BY THIS PLAT

