

## 6. Traffic and Improvement Analysis

### Level of Service Analysis

#### Roadway Performance

Exhibit 14 summarizes the new ADT and daily volume capacity (LOS D) of the roadway segment with and without the project in 2017.

The table show that based on the growth of 3%/year estimated for the background traffic, and the LOS D criteria found in FDOT's *Generalized Annual Average Traffic Volumes in Urbanized Areas*, the 2017 no project and 2017 with project volumes will not exceed the theoretical daily service volume LOS D thresholds.

Note that we estimated that half of the no project traffic south of Valencia Road to Star Valley would use Wade Road and the other half would use Camino Verde.

**Exhibit 14 Future Roadway Volumes and Capacity**

Roadway Segment	2017 ADT (No Project)*	Site Traffic	2017 ADT (With Project)	LOS D Threshold**
Valencia Road: West of Wade Road	9,863	1,652	11,515	15,930
Valencia Road: Wade Road to Camino Verde	17,464	2,479	19,943	35,800
Valencia Road: East of Camino Verde	14,432	1,652	16,085	35,800
Wade Road: South of Valencia	4,202	826	5,028	15,540
Camino Verde: North of Valencia	8,323	826	9,149	15,540
Camino Verde: South of Valencia	4,202	551	4,752	15,540

\*Assumed 3%/year growth

#### Intersection Performance

For the year 2017, we analyzed the project intersections with and without project trips. The results for the peak hour intersection analysis are provided in Exhibit 15 (no project) and Exhibit 16 (with project).

As shown in the summary tables, all intersections will operate at LOS D or better with and without the project.

**Exhibit 15 Intersections Performance – 2017 (No Project)**

		2017 No Project			
		AM		PM	
		Delay (sec/veh)	LOS	Delay (sec/veh)	LOS
Eastbound					
	Left	29.0	C	20.8	C
	Through/Right	23.3	C	19.2	B
	Approach	25.4	C	19.7	B
Westbound					
	Left	20.0	B	22.0	C
	Through	18.7	B	21.7	C
	Right	17.2	B	17.8	B
	Approach	18.7	B	21.2	C
Northbound					
	Left	13.3	B	21.9	C
	Through	20.3	C	17.4	B
	Right	17.9	B	17.0	B
	Approach	19.0	B	17.2	B
Southbound					
	Left	16.8	B	14.6	B
	Through/Right	17.7	B	35.3	D
	Approach	17.3	B	32.1	C
<b>Intersection</b>		<b>22.0</b>	<b>C</b>	<b>23.5</b>	<b>C</b>

		2017 No Project			
		AM		PM	
		Delay (sec/veh)	LOS	Delay (sec/veh)	LOS
Eastbound					
	Left	8.8	A	8.7	A
	Through	11.1	B	9.9	A
	Right	9.0	A	8.7	A
	Approach	10.9	B	9.7	A
Westbound					
	Left	6.3	A	4.4	A
	Through/Right	4.3	A	4.5	A
	Approach	5.2	A	4.4	A
Northbound					
	Left	12.3	B	11.3	B
	Through/Right	13.8	B	11.1	B
	Approach	13.7	B	11.2	B
Southbound					
	Left	N/A	-	N/A	-
	Through/Right	N/A	-	N/A	-
	Approach	N/A	-	N/A	-
<b>Intersection</b>		<b>13.4</b>	<b>B</b>	<b>6.7</b>	<b>A</b>

**Exhibit 16 Intersections Performances – 2017 With Project**

Valencia/Camino Verde		2017 With Project			
		AM		PM	
		Delay (sec/veh)	LOS	Delay (sec/veh)	LOS
Eastbound					
Left Through/Right Approach		30.9	C	22.6	C
		23.8	C	19.4	B
		26.3	C	20.3	C
Westbound					
Left Through/Right Approach		20.4	C	24.1	C
		18.9	B	22.4	C
		17.2	B	17.8	B
		18.9	B	22.1	C
Northbound					
Left Through/Right Approach		13.5	B	23.9	C
		20.3	C	17.7	B
		17.9	B	17.3	B
		18.9	B	18.1	B
Southbound					
Left Through/Right Approach		16.8	B	14.9	B
		17.8	B	40.4	D
		17.3	B	36.6	D
<b>Intersection</b>		<b>22.4</b>	<b>B</b>	<b>25.2</b>	<b>C</b>

Valencia/Wade		2017 With Project			
		AM		PM	
		Delay (sec/veh)	LOS	Delay (sec/veh)	LOS
Eastbound					
Left Through/Right Approach		13.8	B	21.4	C
		17.6	B	15.2	B
		13.6	B	13.8	B
		17.0	B	16.2	B
Westbound					
Left Through/Right Approach		14.0	B	10.3	B
		8.6	A	11.2	B
		10.7	B	11.1	B
Northbound					
Left Through/Right Approach		19.3	B	21.7	C
		20.0	C	21.8	C
		20.0	C	21.6	C
Southbound					
Left Through/Right Approach		20.9	C	21.6	C
		20.3	C	19.3	B
		20.7	C	20.9	C
<b>Intersection</b>		<b>15.5</b>	<b>B</b>	<b>14.0</b>	<b>B</b>

Valencia Project Driveways		2017 With Project			
		AM		PM	
		Delay (sec/veh)	LOS	Delay (sec/veh)	LOS
Valencia/Dwy 1 SB Right		9.0	A	11.1	B
Valencia/Dwy 2 SB Right		9.0	A	9.6	A
Valencia/Dwy 3 SB Right		9.0	A	9.0	A

Wade Project Driveways		2017 With Project			
		AM		PM	
		Delay (sec/veh)	LOS	Delay (sec/veh)	LOS
Wade/Dwy 1					
EB Left/Right NB Left		8.4	A	8.9	A
		2.5	A	2.7	A
Wade/Dwy 2					
EB Left/Right NB Left		8.4	A	8.7	A
		3.7	A	3.9	A
Wade/Dwy 3					
EB Left/Right NB Left		8.3	A	8.5	A
		7.2	A	7.3	A

**Traffic Safety**

**Sight Distance**

The project driveways and intersections should be designed to allow for acceptable sight distance. Sight distance is typically shown on the development plan and improvement drawings. The guidelines for sight distance are provided in Pima County’s Roadway Design Manual.

**Turn Lane Analysis**

A turn lane “warrant” is a justification for constructing a turn lane, based on traffic volumes at an intersection. Turn lanes are warranted based on these criteria when the peak hour turn lane volume exceeds a trigger based on the two-way daily volume (ADT, or Average Daily Traffic as indicated in the table) on the roadway.

Pima County’s Subdivision and Development Street Standards provides turn lane warrant guidelines for County roadways. These guidelines are shown in Exhibit 17.

**Exhibit 17 Turn Lane Warrant Criteria**

*Table 3.4. Maximum left turn volume in the peak hour without a left turn lane (modified from IHSDM<sup>13</sup>)*

Posted Speed (mph)	ADT (2-way)			
	<2,500	2,500-5,000	5,000-10,000	>10,000
≤ 35	75	50	30	15
40-60	75	40	20	10
≥ 65	75	30	10	5

*Table 3.5. Peak Hour Volume Warrant for Right Turn Lanes (modified from IHSDM<sup>13</sup>)*

ADT (2-way)	Max. Peak Hour Right Turn Volume (w/o RT Lane)
2,500-5,000	100
5,000-10,000	70
>10,000	40

Based on the warrants, an eastbound left turn lane, a southbound left turn lane and a westbound right turn lane are warranted at the Valencia Road/Wade Road intersection. A 150 foot eastbound left turn lane is being constructed as part of the Valencia Road (Mark to Wade) widening project.

**Turn Lane Design**

Turn lane design standards are found in the Pima County Roadway Design Manual and the PC/COT Pavement Marking Standards. The Tucson Mountain Commercial project will require a north connection from the Valencia/Wade intersection. This connection should include an exclusive southbound left turn lane. A westbound right turn lane is also warranted at this intersection.

The southbound left turn lane should be designed to a minimum 110 feet in length with transition and taper designed to Pima County standards. It should be noted that a longer turn lane will likely be necessary with the entire Tucson Mountain Ranch project. The north leg of this intersection should be designed to accommodate a future longer left turn lane or be constructed as a three-lane roadway with one lane in each direction and a two-way left turn lane.

#### **Pedestrian, Bicycle, and Transit Considerations**

Sidewalks and bike lanes will be constructed on Valencia Road as part of the current RTA project. There are no bus routes in the vicinity of the project. Sidewalks should be constructed on the west side of Wade Road and along Valencia Road along the frontage of the project.

#### **Speed Considerations**

When Wade Road is opened north of Valencia Road, the County will need to assess the future speed limit for this roadway based on its future functional classification.

#### **Other Considerations**

##### **North Leg of Valencia/Wade**

Wade Road, north of Valencia Road is shown on the current Major Streets and Scenic Routes Plan (MSSRP) map as a roadway with a 150' right-of-way. Pima County is proposing to revise the MSSRP and Wade Road is proposed to be reclassified as a low volume arterial with a 90' right of way.

The roadway plans for Valencia Road, Wade Road to Mark Road (Pima County Project No. 4RTVMW) do not include the construction of a north leg at the Valencia/Wade intersection. A new drainage structure is shown on the north side of this intersection. This drainage structure is part of a new reinforced concrete box culvert shown to go under Valencia Road and to "daylight" on the north side of Valencia Road where the north leg of the intersection would be located. We recommend that Pima County relocate, or reconfigure this structure to allow the future construction of the north leg of this intersection.

##### **Corner and Driveway Clearances**

The site plan shows that the driveway spacings and corner clearances for the driveways on Valencia Road meet the County standard of a minimum 230 feet for a 45 mph roadway. The site plan shows that the driveway spacings and corner clearances for the driveways on Wade Road meet the County standard of a minimum 150 feet for a 35 mph roadway.

##### **Queuing Analysis**

Pima County requires an assessment of storage length estimates for intersection turn lanes based on anticipated traffic at study area intersections. For roadways that are posted for 40 mph or above, the minimum storage length standard in Pima County is a 150 feet for turn lanes on roadways. For less than 40 mph, the minimum storage length is 110 feet. Driveways should be designed to have a minimum 50 foot throat length, so this was considered to be the minimum length for queue from the driveways.

Storage lengths should be extended if existing or projected traffic volumes at intersections queue beyond the calculated 95<sup>th</sup> percentile queue length, so that queuing vehicles do not back up and encroach into other lanes.

The Synchro software estimates queue lengths for all intersection turning movements. Exhibit 18 shows the existing storage lengths for turn lanes at the project area intersections and indicates whether the calculated 95<sup>th</sup> percentile queue lengths exceed the physical storage lengths of the turn lanes. The analysis

was done for the year 2017 “With Project” conditions. These estimates should not be used for design purposes. A reassessment of the queue lengths should be conducted at the development plan stage.

### **Travel Demand Management**

There are no TDM elements associated with this project.

### **Tucson Mountain Ranch Cluster Development**

This commercial project is located at the southeast corner of the larger Tucson Mountain Ranch Cluster Development. A site analysis document for this larger project was prepared by The WLB Group in 2014. This development is a 461 residential lot project with access onto Wade Road, Valencia Road and Valhalla Road. If this project is constructed as planned, it will add approximately 4,500 additional daily trips and 460 peak hour trips to the area. This project is still in the rezoning stages and no schedule has been developed for the build out of this project. However, a traffic study should be conducted at the development plan stage to determine infrastructure needs as a result of the impact of this project.

**Exhibit 18 Turn Lane Storage and Queue Lengths**

Valencia/Camino Verde				95% Queue Length (ft)	
				2017 With Project	
	Speed Limit	Existing or Planned Storage (ft)	Pima County Standard (ft)	AM	PM
Eastbound					
Left	45	400	150	204	62
Westbound					
Left	45	190	150	24	101
Right		190	150	0	24
Northbound					
Left	35	200	110	11	15
Right		200	110	43	14
Southbound					
Left	45	350	150	57	43

Valencia/Wade				95% Queue Length (ft)	
				2017 With Project	
	Speed Limit	Existing Storage (ft)	Pima County Standard (ft)	AM	PM
Eastbound					
Left	45	200	150	25	88
Right	45	150	150	7	0
Westbound					
Left	45	500	150	65	68
Northbound					
Left	35	400	110	35	31
Southbound					
Left	25	N/A	110	24	74

Valencia/Project Driveways				95% Queue Length (ft)	
				2017 With Project	
	Speed Limit	Existing Storage (ft)	Pima County Standard (ft)	AM	PM
Valencia/Dwy 1 SB R	25	N/A	110	1	6
Valencia/Dwy 2 SB R	25	N/A	110	1	4
Valencia/Dwy 2 SB R	25	N/A	110	1	4

Wade/Project Driveways				95% Queue Length (ft)	
				2017 With Project	
	Speed Limit	Existing Storage (ft)	Pima County Standard (ft)	AM	PM
Wade/Dwy 1 EB R	25	N/A	110	1	4
Wade/Dwy 1 NB L	25	N/A	110	1	3
Wade/Dwy 2 EB R	25	N/A	110	1	4
Wade/Dwy 2 NB L	25	N/A	110	1	3
Wade/Dwy 3 EB R	25	N/A	110	1	3
Wade/Dwy 3 NB L	25	N/A	110	1	3

## 7. Conclusions and Recommendations

1. The project will generate approximately:
  - 124 morning peak hour trips,
  - 479 evening peak hour trips,
  - 5,508 weekday trips.
2. Valencia Road is under construction to be widened to a four-lane desert parkway from Wade Road to Mark Road. Plans should be modified to construct the north leg of the Valencia/Wade intersection.
3. Full access is possible at the driveways on Wade Road. Access locations on Valencia Road should be limited to right-in, right-out movements due to the planned construction of the raised median on Valencia Road.
4. The southbound approach of the intersection at Valencia/Wade should include an exclusive 110 minimum foot left turn lane and a shared through/right lane. The westbound approach should have a 150 foot minimum right turn lane. A preliminary queuing analysis shows that the 95<sup>th</sup> percentile queue lengths based on the Synchro analysis and the impact of this project are less than the Pima County minimum length standards. The County may wish to extend these lanes, or construct the north leg of the intersection as a three lane road to accommodate future Tucson Mountain Ranch residential traffic.
5. Turn lanes are not numerically warranted at all other project driveways.
6. Sidewalks and bike lanes should be constructed on the west side of Wade Road along the frontage of the property.
7. Sight distance at the project intersections should be ensured according to criteria in the Pima County *Roadway Design Manual*.
8. All signs and pavement markings associated with the recommended improvements must conform to the MUTCD and Pima County requirements.



## APPENDIX

- TIA Checklist
  - Traffic Data
- Synchro Analysis Sheets

# M ESPARZA ENGINEERING TRANSPORTATION IMPACT STUDY CHECKLIST AND SUBMITTAL FORM

Please complete this form PRIOR TO PREPARING A TRAFFIC REPORT.

Submit the completed and approved form with your study. Studies will not be submitted without this checklist attached. (Approval of this form does not constitute approval of the study.)

Project Name: Tucson Mountain Ranch Commercial (ME Eng 2015.03)

Project Location: Northwest corner of Valencia Road/Wade Road (site plan attached)

Applicant/Developer: G. Paul Oland (The WLB Group) for Gus Fotinos

Consultant: M Esparza Engineering, LLC

Address: 6542 W Winter Valley Way

Phone: 520-207-3358

City/Town: Tucson

State: Arizona

E-mail: mue-cla@cox.net

Arizona Civil Engineering Registrant? Yes

Was the consultant actively involved in the site circulation, roadway layout, and selection of access locations? No.

Brief description of project:

Commercial project with 129,000 square feet of commercial/retail uses. Access is shown on the site plan at three locations on Valencia Road and at three locations on an extension of Wade Road, north of Valencia Road.

Current and proposed zoning:

Current zoning is County Manufactured and Mobile Home Zone 1 (CMH-1). The proposed zoning is Local Business Zone (CB-1)

Pre-submittal Meeting Held on 3/26/2015

Summary of Meeting:

Traffic topics discussed: The north Wade Road extension conflicting with Valencia Road widening plans; the number of access points on Valencia Road and Wade Road, and access on Valencia Road from the planned development south of Valencia Road.

Nature of Transportation Study – To support a rezoning application.

Rezoning study?	<input checked="" type="checkbox"/> Yes	No
Development Plan?	<input type="checkbox"/> Yes	No
Block Plat?	<input type="checkbox"/> Yes	No
Subdivision Plat?	<input type="checkbox"/> Yes	No

New Median Openings requested?	Yes	No (A possible opening at the western Valencia access – to be discussed in the TIS)
Access via Non-Agency Roadways?	Yes	xNo
Coordination with Multiple Agency(s)?	Yes	xNo

**Transportation Study Parameters**

**Trip Generation** Land Use Categories and Rates: Shopping Center use (ITE LU Code 820) for 129 KSF will generate 124 am peak hour, 479 pm peak hour and 5,508 daily trips at buildout. As such we will prepare a Category 1 TIS.

**Horizon Year(s)** 2017 is the assumed buildout year. A growth rate of 3%/year will be applied to estimate background traffic for the buildout year.

**Passer-by Traffic & Internal Capture** Pass-by trip reduction of 34% in the pm peak hour per ITE Trip Generation Handbook for Shopping Center.

**Alternate Modes Considerations** Bikes: Bike lanes are being constructed on both sides of Valencia Road from Mark to Wade. There are bike lanes on each side of Wade Road south of Valencia Road.  
Pedestrian Facilities: A sidewalk is being constructed with the Valencia Road project from Wade to Camino Verde on the north side of Valencia. A multi-use path is being constructed on the south side of Valencia from Wade to the east. There are no pedestrian facilities on Wade Road.

**Traffic Data** Pima County provided 2014 counts at the Valencia/Wade and Valencia/Camino Verde intersection. I collected 1 hour peak hour counts at the Valencia/Camino Verde intersection after the opening of the south leg. 24 hour roadway volumes on Valencia, Wade and Camino Verde are available from Pima County and PAG. Crash data is available from Pima County's SMS.

**Analysis Elements and Methods**

**Roadways** Our analysis will focus on the roadways (Valencia, Wade and Camino Verde) in the vicinity of the project access locations. We will assess the daily service volumes and capacities on these roads with and without the project.

**Intersections** We will analyze the project access intersections and the Valencia/Wade and Valencia/Camino Verde intersections using either the Highway Capacity Software or Synchro.

**Special Considerations** Based on the one-hour am and pm peak hour counts I collected at Valencia/Camino Verde following the opening of Camino Verde to the south, I will estimate the redistribution in traffic volumes from the collected traffic volumes in 2014 at Valencia/Camino Verde and Valencia/Wade. I have estimated that 30% of the site traffic will be to the east and 30% to the west on Valencia; 15% will go south on Wade, 15% to the north on Camino Verde and 10% south on Camino Verde. We will generally discuss the impacts of the development to the south and the larger Tucson Mountain Ranch project.

***We concur that the information above is correct and that the study will include the parameters and elements described above.***

Consultant Concurrence in Study Requirements Consultant signature: 

Printed name: Marcos Esparza, P.E.

Title: Principal

Date: 5-15-2015

\*Checklist Approved

Agency authorized signature:

Printed name:

Title:

Date:

M ESPARZA ENGINEERING USE ONLY:

\* As there may be instances when one or more study requirements are inadvertently not discussed during the pre-submittal meeting, additional study parameters or elements (other than those discussed in this Checklist) may be required following the first submittal of the study if the agency deems that they are critical to the study findings.

# Site Plan

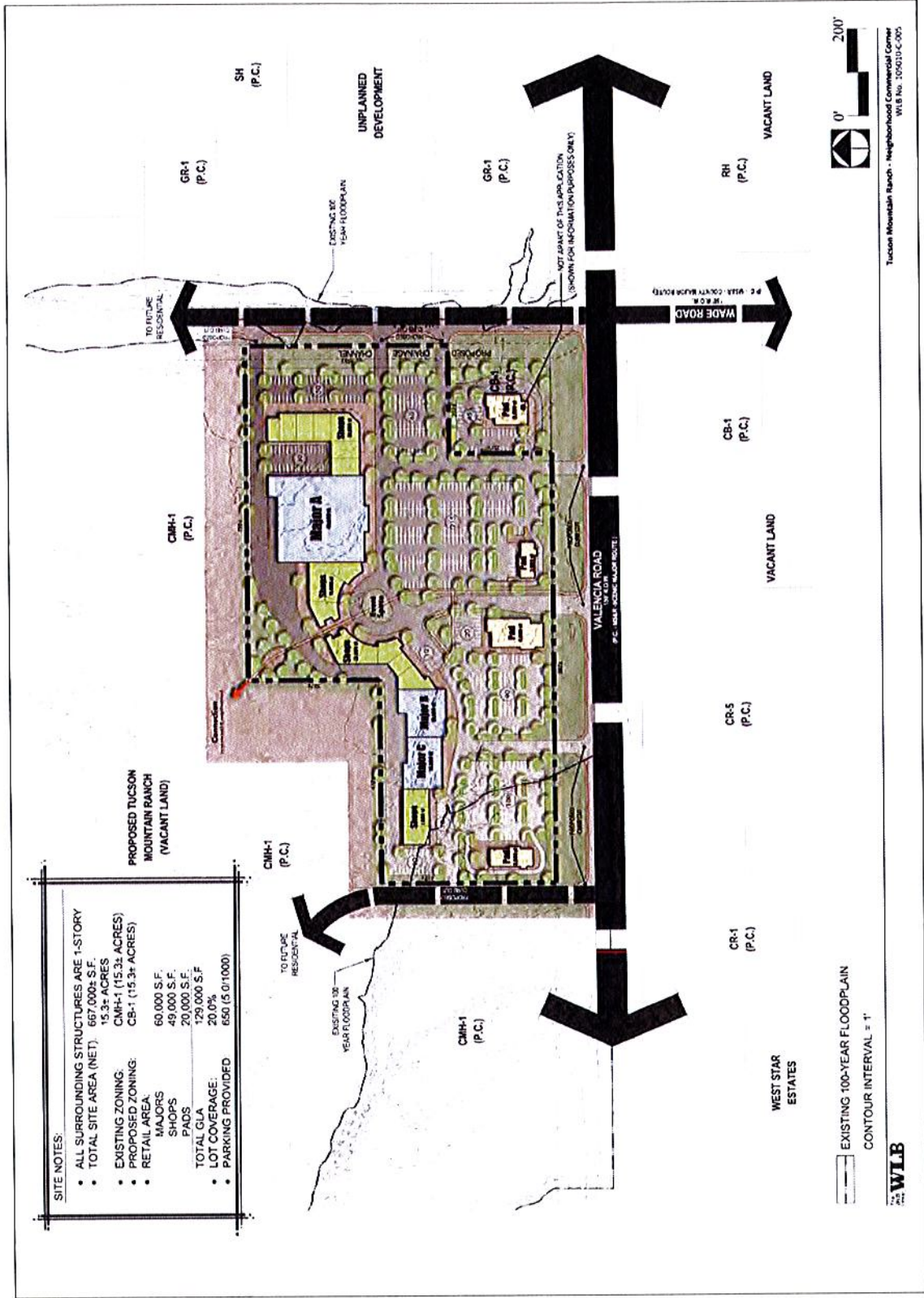

**Preliminary Trip Generation**

<i>Proposed Use</i>	<i>Unit</i>	<i>No.Units</i>	<i>ITE Categ.</i>	<i>Weekday AM</i>		<i>Weekday PM</i>		<i>Avg Weekday</i>	
				<i>In</i>	<i>Out</i>	<i>In</i>	<i>Out</i>	<i>In</i>	<i>Out</i>
Shopping Center	1000 SF	129.0	820	0.96		3.71		42.7	
				62%	38%	48%	52%	50%	50%

<i>Proposed Use</i>	<i>Unit</i>	<i>No. Units</i>	<i>Weekday AM</i>		<i>Weekday PM</i>		<i>Avg Weekday</i>	
			<i>In</i>	<i>Out</i>	<i>In</i>	<i>Out</i>	<i>In</i>	<i>Out</i>
Shopping Center	1000 SF	129.0	124		479		5,508	
			77	47	230	249	2,754	2,754

<i>PASS-BY TRIPS</i>	<i>ITE Categ.</i>	<i>Pass-by Rate</i>	<i>Weekday AM</i>		<i>Weekday PM</i>		<i>Avg Weekday</i>	
			<i>In</i>	<i>Out</i>	<i>In</i>	<i>Out</i>	<i>In</i>	<i>Out</i>
Shopping Center	820	34%	0		163		0	
		PM	0	0	78	85	0	0

<i>Net Trips</i>	<i>Unit</i>	<i>No. Units</i>	<i>Weekday AM</i>		<i>Weekday PM</i>		<i>Avg Weekday</i>	
			<i>In</i>	<i>Out</i>	<i>In</i>	<i>Out</i>	<i>In</i>	<i>Out</i>
Shopping Center	1000 SF	129.0	124		316		5,508	
			77	47	152	164	2,754	2,754

**Project: Valencia/Wade**  
**Date: Tuesday, October 21, 2014**

0.15

**Count Starts at**

END Time	EB Valencia		WB Valencia		NB Wade		SB Wade		TOTALS						
	Left Turn	Right Turn	Left Turn	Right Turn	Left Turn	Right Turn	Left Turn	Right Turn	EB	WB	NB	SB	Total	END Time	
7:00 AM	0	150	5	27	41	0	7	0	186	0	0	0	0	0	7:15 AM
7:15 AM	0	162	8	23	45	0	9	0	178	0	0	0	0	0	7:30 AM
7:30 AM	0	137	22	56	27	0	3	0	163	0	0	0	0	0	7:45 AM
7:45 AM	0	116	38	62	38	0	14	0	146	0	0	0	0	0	8:00 AM
8:00 AM	0	90	18	68	31	0	23	0	167	0	0	0	0	0	8:15 AM
8:15 AM	0	102	2	32	35	0	6	0	106	0	0	0	0	0	8:30 AM
8:30 AM	0	87	4	34	49	0	0	0	81	0	0	0	0	0	8:45 AM
8:45 AM	0	93	0	31	26	0	5	0	82	0	0	0	0	0	9:00 AM
9:00 AM	0	565	73	168	151	0	33	0	673	0	0	0	0	0	9:00 AM
7:00 AM	0	505	86	209	141	0	49	0	654	0	0	0	0	0	8:00 AM
7:15 AM	0	445	80	218	131	0	46	0	582	0	0	0	0	0	8:15 AM
7:30 AM	0	395	62	196	153	0	43	0	500	0	0	0	0	0	8:30 AM
7:45 AM	0	372	24	165	141	0	34	0	436	0	0	0	0	0	8:45 AM
8:00 AM	0	937	97	333	292	0	67	0	1109	0	0	0	0	0	9:00 AM
TOTALS	0	565	73	168	151	0	33	0	673	0	0	0	0	0	PHF
2014 NP	0	565	73	168	151	0	33	0	673	0	0	0	0	0	
Adjust from Val/CV Count	0	-51	4	-345	0	0	-4	0	-345	0	0	0	0	0	
Adjusted 2015 Count	0	565	73	117	155	0	29	0	328	0	0	0	0	0	
2017 NP	0	599	77	124	164	0	31	0	348	0	0	0	0	0	
Site Trips	11	7	19	19	20	20	12	12	348	16	7	14	14	14	
2017 WP	11	606	77	124	183	20	31	12	348	16	7	14	14	14	

**Count Starts at**

END Time	EB Valencia		WB Valencia		NB Wade		SB Wade		TOTALS						
	Left Turn	Right Turn	Left Turn	Right Turn	Left Turn	Right Turn	Left Turn	Right Turn	EB	WB	NB	SB	Total	END Time	
4:00 PM	0	58	7	92	107	0	13	0	45	0	0	0	0	0	4:15 PM
4:15 PM	0	45	9	92	107	0	7	0	53	0	0	0	0	0	4:30 PM
4:30 PM	0	65	3	105	110	0	3	0	47	0	0	0	0	0	4:45 PM
4:45 PM	0	77	5	84	135	0	3	0	57	0	0	0	0	0	5:00 PM
5:00 PM	0	67	9	104	119	0	5	0	60	0	0	0	0	0	5:15 PM
5:15 PM	0	85	11	143	145	0	6	0	56	0	0	0	0	0	5:30 PM
5:30 PM	0	49	2	130	117	0	5	0	70	0	0	0	0	0	5:45 PM
5:45 PM	0	59	9	126	159	0	6	0	52	0	0	0	0	0	6:00 PM
6:00 PM	0	245	24	373	459	0	26	0	202	0	0	0	0	0	6:00 PM
4:00 PM	0	254	26	385	471	0	18	0	217	0	0	0	0	0	5:00 PM
4:15 PM	0	294	28	436	509	0	17	0	220	0	0	0	0	0	5:15 PM
4:30 PM	0	278	27	461	516	0	19	0	243	0	0	0	0	0	5:30 PM
4:45 PM	0	260	31	503	540	0	22	0	238	0	0	0	0	0	5:45 PM
5:00 PM	0	505	55	876	999	0	48	0	440	0	0	0	0	0	6:00 PM
4:00 PM	0	260	31	503	540	0	22	0	238	0	0	0	0	0	PHF
2014 NP	0	260	31	503	540	0	22	0	238	0	0	0	0	0	
Adjust from Val/CV Count	0	-2	-377	3	-157	0	-3	0	-157	0	0	0	0	0	
Adjusted 2015 Count	0	260	29	126	543	0	19	0	81	0	0	0	0	0	
2017 NP	0	276	31	134	576	0	20	0	86	0	0	0	0	0	
Site Trips	22	28	38	38	38	38	23	23	86	54	25	49	49	49	
2017 WP	22	304	31	134	614	38	20	23	86	54	25	49	49	49	

**Project: Valencia/Camino Verde**  
**Date: Tuesday, October 21, 2014**

0:15

**Count Starts at**

END Time	EB Valencia		WB Valencia		NB Camino Verde		SB Camino Verde		TOTALS					
	Left Turn	Right Turn	Left Turn	Right Turn	Left Turn	Right Turn	Left Turn	Right Turn	EB	WB	NB	SB	Total	END Time
7:00 AM														
7:15 AM	118	182	0	0	0	46	3	0	0	0	22	0	17	7:15 AM
7:30 AM	125	199	0	0	51	8	0	0	0	0	26	0	26	7:30 AM
7:45 AM	126	191	0	0	52	9	0	0	0	0	31	0	31	7:45 AM
8:00 AM	101	166	0	0	80	8	0	0	0	0	27	0	45	8:00 AM
8:15 AM	115	167	0	0	67	11	0	0	0	0	20	0	25	8:15 AM
8:30 AM	73	137	0	0	46	12	0	0	0	0	21	0	25	8:30 AM
8:45 AM	54	99	0	0	43	4	0	0	0	0	23	0	29	8:45 AM
9:00 AM	62	90	0	0	46	18	0	0	0	0	21	0	15	9:00 AM
7:00 AM	470	738	0	0	229	28	0	0	0	0	106	0	119	8:00 AM
7:15 AM	467	723	0	0	230	36	0	0	0	0	104	0	127	8:15 AM
7:30 AM	415	661	0	0	245	40	0	0	0	0	99	0	126	8:30 AM
7:45 AM	343	569	0	0	236	35	0	0	0	0	91	0	124	8:45 AM
8:00 AM	304	493	0	0	202	45	0	0	0	0	85	0	94	9:00 AM
9:00 AM	774	1231	0	0	431	73	0	0	0	0	191	0	213	9:00 AM
2014 NP	470	738	0	0	229	28	0	0	0	0	106	0	119	
2015 Turns Count				35			4	162	183				16	
Subtract	-162	-183			-35								-16	
Adjusted 2015 Count	308	555	0	35	194	28	4	162	183	106	16	103	103	
2017 NP	326	588	0	37	206	30	4	172	194	112	17	109	109	
Site Trips	7	14	2		23		4						12	
2017 WP	333	602	2	37	229	30	8	172	194	112	17	121	121	

PHF

0.93 0.73 ##### 0.78

**Count Starts at**

END Time	EB Valencia		WB Valencia		NB Camino Verde		SB Camino Verde		TOTALS					
	Left Turn	Right Turn	Left Turn	Right Turn	Left Turn	Right Turn	Left Turn	Right Turn	EB	WB	NB	SB	Total	END Time
4:00 PM														
4:15 PM	27	63	0	0	113	32	0	0	0	0	18	0	82	4:15 PM
4:30 PM	38	66	0	0	115	31	0	0	0	0	20	0	68	4:30 PM
4:45 PM	39	71	0	0	144	39	0	0	0	0	22	0	64	4:45 PM
5:00 PM	49	77	0	0	126	41	0	0	0	0	15	0	86	5:00 PM
5:15 PM	45	93	0	0	161	38	0	0	0	0	22	0	74	5:15 PM
5:30 PM	33	89	0	0	177	29	0	0	0	0	16	0	109	5:30 PM
5:45 PM	45	95	0	0	128	33	0	0	0	0	20	0	110	5:45 PM
6:00 PM	25	68	0	0	161	23	0	0	0	0	17	0	115	6:00 PM
4:00 PM	153	277	0	0	498	143	0	0	0	0	75	0	300	5:00 PM
4:15 PM	171	307	0	0	546	149	0	0	0	0	79	0	292	5:15 PM
4:30 PM	166	330	0	0	608	147	0	0	0	0	75	0	333	5:30 PM
4:45 PM	172	354	0	0	592	141	0	0	0	0	73	0	379	5:45 PM
5:00 PM	148	345	0	0	627	123	0	0	0	0	75	0	408	6:00 PM
6:00 PM	301	622	0	0	1125	266	0	0	0	0	150	0	708	6:00 PM
2014 NP	148	345	0	0	627	123	0	0	0	0	75	0	408	
2015 Turns Count				198			3	55	102				179	
Subtract	-55	-102			-198								-179	
Adjusted 2015 Count	93	243	2	198	429	123	3	55	102	75	179	229	229	
2017 NP	99	258	2	210	455	130	3	58	108	80	190	243	243	
Site Trips	25	49	8		45		8						23	
2017 WP	124	307	10	210	500	130	11	58	108	80	190	266	266	

PHF

0.88 0.91 ##### 0.91

PIMA COUNTY DEPARTMENT OF TRANSPORTATION  
TRAFFIC ENGINEERING

24HR INTERSECTION APPROACH TOTALS FOR: CAMINO VERDE  
AT THE INTERSECTION OF: VALENCIA RD

INFO 1 ROAD: NB LOCATION: 350'N VALENCIA RD

INFO 2 ROAD: LOCATION:

INFO 3 ROAD: WB LOCATION: 400'E CAMINO VERDE

INFO 4 ROAD: EB LOCATION: 400'W CAMINO VERDE

DATE	TIME	SB	WB	EB	
10/07/2013	10:00	139	0	254	362
	11:00	163	0	274	375
	12:00	145	0	354	394
	13:00	172	0	363	384
	14:00	212	0	419	373
	15:00	264	0	509	363
	16:00	365	0	629	361
	17:00	396	0	689	433
	18:00	361	0	634	374
	19:00	228	0	457	221
	20:00	162	0	388	162
	21:00	134	0	238	122
	22:00	109	0	171	81
	23:00	68	0	93	32
10/08/2013	00:00	29	0	51	25
	01:00	21	0	32	15
	02:00	15	0	17	19
	03:00	11	0	14	46
	04:00	33	0	22	195
	05:00	60	0	60	493
	06:00	107	0	139	709
	07:00	158	0	213	955
	08:00	145	0	221	605
	09:00	128	0	202	455
<b>LANE TOTALS:</b>		<b>3625</b>	<b>0</b>	<b>6443</b>	<b>7554</b>
<b>24HR TOTAL:</b>		<b>17,622 ADT</b>			

Report Generated By: D.Lucero  
12/30/2014



PIMA COUNTY DEPARTMENT OF TRANSPORTATION  
TRAFFIC ENGINEERING

24HR INTERSECTION APPROACH TOTALS FOR: VALENCIA RD  
AT THE INTERSECTION OF: WADE RD

INFO 1      ROAD:          0                                  LOCATION:          0

INFO 2      ROAD: NB    LOCATION: 300'E VALENCIA RD

INFO 3      ROAD: WB    LOCATION: 300'E WADE RD

INFO 4      ROAD: EB    LOCATION: 350' W WADE RD

DATE	TIME	SB	NB	WB	EB
09/10/2013	12:00	0	161	323	189
	13:00	0	155	366	188
	14:00	0	199	446	213
	15:00	0	241	677	223
	16:00	0	186	763	236
	17:00	0	207	913	250
	18:00	0	178	824	223
	19:00	0	127	616	147
	20:00	0	86	547	105
	21:00	0	60	363	61
	22:00	0	35	225	43
	23:00	0	12	137	31
09/11/2013	00:00	0	7	53	17
	01:00	0	6	38	7
	02:00	0	9	26	17
	03:00	0	24	18	25
	04:00	0	97	22	116
	05:00	0	237	73	281
	06:00	0	431	198	418
	07:00	0	633	295	593
	08:00	0	333	302	358
	09:00	0	211	291	240
	10:00	0	164	255	221
	11:00	0	172	268	201
LANE TOTALS:		0	3971	8039	4403
24HR TOTAL:		16,413 ADT			

PIMA COUNTY DEPARTMENT OF TRANSPORTATION  
 TRAFFIC ENGINEERING

24HR AVERAGE DAILY TRAFFIC TOTALS FOR: VALENCIA RD

LOCATION: 1/4MILE W VIA MOLINA DE VIENTO  
 BLOCK NUMBER: W 8670

DATE	TIME	EB	WB
10/7/2013	00:00	7	18
	01:00	3	7
	02:00	4	3
	03:00	6	4
	04:00	27	12
	05:00	52	38
	06:00	63	75
	07:00	86	102
	08:00	81	68
	09:00	91	49
	10:00	74	70
	11:00	75	85
	12:00	75	76
	13:00	77	103
	14:00	75	104
	15:00	92	119
	16:00	79	138
	17:00	110	139
	18:00	92	110
	19:00	35	73
	20:00	32	52
	21:00	25	35
	22:00	9	26
	23:00	5	16
<b>LANE TOTALS:</b>		<b>1,275</b>	<b>1,522</b>
<b>24HR TOTAL:</b>		<b>2,797 ADT</b>	

Report Generated By: D.Lucero  
 12/30/2014

PIMA COUNTY DEPARTMENT OF TRANSPORTATION  
TRAFFIC ENGINEERING

**24HR AVERAGE DAILY TRAFFIC TOTALS FOR: VALENCIA RD**  
LOCATION: 450'W MARK RD  
BLOCK NUMBER: W 5050

DATE	TIME	EB	WB
9/12/2013	00:00	182	108
	01:00	134	47
	02:00	75	46
	03:00	84	39
	04:00	175	34
	05:00	373	126
	06:00	535	243
	07:00	828	353
	08:00	623	378
	09:00	475	428
	10:00	497	488
	11:00	444	485
	12:00	479	500
	13:00	591	532
	14:00	543	625
	15:00	593	789
	16:00	605	906
	17:00	565	970
	18:00	531	1079
	19:00	438	950
	20:00	411	560
	21:00	671	444
	22:00	460	315
	23:00	322	211
<b>LANE TOTALS:</b>		<b>10,634</b>	<b>10,656</b>
<b>24HR TOTAL:</b>		<b>21,290 ADT</b>	

Report Generated By: D.Lucero  
12/30/2014

PIMA COUNTY DEPARTMENT OF TRANSPORTATION  
TRAFFIC ENGINEERING

24HR AVERAGE DAILY TRAFFIC TOTALS FOR: WADE RD

LOCATION: 100' S ADAMSGATE PL  
BLOCK NUMBER: S 6860

DATE	TIME	NB	SB
5/2/2013	00:00	12	53
	01:00	9	30
	02:00	11	21
	03:00	22	10
	04:00	84	17
	05:00	195	40
	06:00	360	95
	07:00	498	101
	08:00	289	114
	09:00	196	140
	10:00	202	125
	11:00	146	121
	12:00	171	169
	13:00	181	170
	14:00	212	221
	15:00	169	302
	16:00	188	342
	17:00	215	432
	18:00	158	322
	19:00	138	306
	20:00	106	282
	21:00	61	182
	22:00	49	139
	23:00	25	72
<b>LANE TOTALS:</b>		<b>3,697</b>	<b>3,806</b>
<b>24HR TOTAL:</b>		<b>7,503 ADT</b>	

Report Generated By: D.Lucero  
12/30/2014

**PIMA COUNTY DEPARTMENT OF TRANSPORTATION  
TRAFFIC ENGINEERING**

**24HR AVERAGE DAILY TRAFFIC TOTALS FOR: CAMINO VERDE**  
**LOCATION: 350' N BILBY RD**  
**BLOCK NUMBER: S 6050**

<b>DATE</b>	<b>TIME</b>	<b>EB</b>	<b>WB</b>
07/29/14	00:00	32	47
Tue	01:00	18	12
	02:00	14	20
	03:00	23	16
	04:00	97	30
	05:00	238	69
	06:00	310	84
	07:00	453	185
	08:00	301	118
	09:00	198	101
	10:00	191	134
	11:00	173	129
	12:00	189	156
	13:00	177	147
	14:00	177	198
	15:00	197	269
	16:00	229	323
	17:00	246	395
	18:00	201	379
	19:00	169	258
	20:00	122	239
	21:00	109	164
Wed	22:00	63	118
07/30/14	23:00	44	74
<b>LANE TOTALS:</b>		<b>3971</b>	<b>3665</b>
<b>24HR TOTAL:</b>		<b>7,636 ADT</b>	

Report Generated By:

Danny Fleming

#####

PIMA COUNTY DEPARTMENT OF TRANSPORTATION  
TRAFFIC ENGINEERING

RUNNING SPEEDS FOR: WADE ROAD  
COUNTER LOCATION: 200' SOUTH OF ADAMSGATE PLACE  
BLOCK NUMBER: 6900 S

START: 09:00 on 08/08/12      END: 21:59 on 08/08/12

		BIN 1	BIN 2	BIN 3	BIN 4	BIN 5	BIN 6	BIN 7	BIN 8	BIN 9	BIN 10	BIN 11	BIN 12	BIN 13	BIN 14	BIN 15	BIN 16	
		MILE PER HOUR (MPH) RANGE																
DATE	TIME	0 - 19.9	20 - 24.9	25 - 29.9	30 - 34.9	35 - 39.9	40 - 44.9	45 - 49.5	50 - 54.9	55 - 59.9	60 - 64.9	65 - 69.9	70 - 74.9	75 - 79.9	80 - 84.9	85 - 89.9	OTHR	TOTAL
<b>ROAD NAME: WADE ROAD</b>																		
	ADT / BIN:	62	31	105	465	1553	2171	1231	493	161	29	7	5	4	1	0	1	6319
	% ADT / BIN:	1%	0%	2%	7%	25%	34%	19%	8%	3%	0%	0%	0%	0%	0%	0%	0%	100%
		<b>AVERAGE SPEED: 42.1 MPH</b>			<b>50% SPEED: 42.2 MPH</b>				<b>85% SPEED: 49.0 MPH</b>									

Report Generated By: T. HOBSON  
12/30/2014

**ROAD NAME: NB WADE RD**

		BIN 1	BIN 2	BIN 3	BIN 4	BIN 5	BIN 6	BIN 7	BIN 8	BIN 9	BIN 10	BIN 11	BIN 12	BIN 13	BIN 14	BIN 15	BIN 16	
		MILE PER HOUR (MPH) RANGE																
DATE	TIME	0 - 19.9	20 - 24.9	25 - 29.9	30 - 34.9	35 - 39.9	40 - 44.9	45 - 49.5	50 - 54.9	55 - 59.9	60 - 64.9	65 - 69.9	70 - 74.9	75 - 79.9	80 - 84.9	85 - 89.9	OTHR	TOTAL
08/08/2012	09:00	0	0	3	7	27	50	38	28	13	1	2	0	0	0	0	0	170
	09:00	8	0	0	7	35	48	15	1	1	0	0	0	0	0	0	0	115
	10:00	0	0	2	7	18	38	41	22	5	1	0	0	0	0	0	0	134
	10:00	3	0	1	6	41	38	18	2	0	0	0	0	0	0	0	0	109
	11:00	1	0	2	7	20	38	33	15	10	1	0	0	0	1	0	0	128
	11:00	3	1	4	10	28	23	9	4	1	0	0	0	0	0	0	0	81
	12:00	0	0	1	9	24	28	33	19	8	1	0	0	0	0	0	0	123
	12:00	1	0	1	10	42	34	21	5	0	0	0	0	0	0	0	0	114
	13:00	0	0	1	7	13	44	34	25	8	2	0	0	0	0	0	0	134
	13:00	3	6	1	10	28	54	28	12	0	1	0	0	0	0	0	0	143
	14:00	0	0	3	8	42	57	44	28	11	0	0	0	0	0	0	0	189
	14:00	0	2	2	13	53	81	31	4	1	0	0	0	2	0	0	0	189
	15:00	0	0	3	3	20	48	30	15	9	0	0	0	0	0	0	0	128
	15:00	2	0	3	27	71	125	40	3	0	1	0	0	0	0	0	0	272
	16:00	0	0	0	5	24	43	34	26	4	0	0	0	1	0	0	0	137
	16:00	0	0	0	10	80	145	55	7	3	0	0	1	0	0	0	0	301
	17:00	1	0	0	10	22	42	51	36	11	2	0	0	0	0	0	0	175
	17:00	1	0	0	23	111	171	56	8	2	1	0	0	0	0	0	0	373
	18:00	0	0	1	16	41	37	45	17	6	2	0	0	0	0	0	0	164
	18:00	1	1	2	22	119	128	32	5	1	1	1	0	0	0	0	0	313
	19:00	0	1	3	7	20	30	23	5	5	1	0	0	0	0	0	0	95
	19:00	2	1	5	23	101	102	30	2	0	0	0	1	0	0	0	0	267
	20:00	0	0	1	7	28	33	13	10	1	0	0	0	0	0	0	0	91
	20:00	0	1	11	35	59	58	14	1	0	0	0	0	0	0	0	0	179
	21:00	0	0	1	5	14	17	19	6	0	0	0	0	0	0	0	0	62
	21:00	1	1	4	10	61	55	19	1	0	0	0	0	0	0	0	0	152
	22:00	0	0	0	5	7	8	13	2	2	0	0	0	0	0	0	0	37
	22:00	0	0	0	11	31	44	11	3	0	0	0	0	0	0	0	0	100
	23:00	0	0	1	1	3	8	5	0	1	0	0	0	0	0	0	0	17
	23:00	0	0	0	9	15	12	18	3	1	0	0	0	0	0	0	0	58
08/09/2012	00:00	0	0	0	1	1	5	0	2	0	1	0	0	0	0	0	0	10
08/09/2012	00:00	0	0	0	4	7	13	4	2	0	0	0	0	0	0	0	0	30
	01:00	0	0	1	0	2	2	3	0	0	0	0	1	0	0	0	0	9
	01:00	0	2	0	0	5	10	3	0	0	0	0	0	0	0	0	0	20
	02:00	0	0	0	0	2	1	2	2	2	1	0	0	0	0	0	0	10
	02:00	0	1	0	1	5	7	2	2	0	0	0	0	1	0	0	0	19
	03:00	0	0	0	0	4	5	4	4	3	1	0	0	0	0	0	0	21
	03:00	0	0	0	2	6	1	2	3	0	0	0	0	0	0	0	0	14
	04:00	0	1	0	2	9	21	28	4	2	3	2	2	0	0	0	0	72
	04:00	0	0	0	2	2	3	0	1	1	0	0	0	0	0	0	0	8
	05:00	0	1	3	10	26	36	48	38	16	3	1	0	0	0	0	0	178
	05:00	1	0	2	5	17	11	5	1	1	0	0	0	0	0	0	0	43
	06:00	0	1	2	11	69	124	99	53	11	4	0	0	0	0	0	0	374
	06:00	5	2	1	11	18	28	6	2	0	0	0	0	0	0	0	0	71
	07:00	24	9	32	54	80	107	73	26	8	0	0	0	0	0	0	0	413
	07:00	2	0	5	3	27	34	10	1	0	1	0	0	0	0	0	0	83
	08:00	1	0	2	18	47	85	76	40	12	0	1	0	0	0	0	0	282
	08:00	2	0	1	14	34	42	16	1	1	0	0	0	0	0	0	1	112
	ADT / BIN:	62	31	105	465	1553	2171	1231	493	161	29	7	5	4	1	0	1	6319
	% ADT / BIN:	1%	0%	2%	7%	25%	34%	19%	8%	3%	0%	0%	0%	0%	0%	0%	0%	100%
		<b>AVERAGE SPEED: 42.1 MPH</b>			<b>50% SPEED: 42.2 MPH</b>				<b>85% SPEED: 49.0 MPH</b>									

PIMA COUNTY DEPARTMENT OF TRANSPORTATION  
TRAFFIC ENGINEERING

RUNNING SPEEDS FOR: WADE ROAD  
COUNTER LOCATION: 200' NORTH OF DOVEWOOD WAY  
BLOCK NUMBER: 7110 S

START: 09:00 on 08/08/12      END: 20:16 on 08/08/12

DATE	TIME	BIN 1	BIN 2	BIN 3	BIN 4	BIN 5	BIN 6	BIN 7	BIN 8	BIN 9	BIN 10	BIN 11	BIN 12	BIN 13	BIN 14	BIN 15	BIN 16	TOTAL
		MILE PER HOUR (MPH) RANGE																
		0 - 19.9	20 - 24.9	25 - 29.9	30 - 34.9	35 - 39.9	40 - 44.9	45 - 49.9	50 - 54.9	55 - 59.9	60 - 64.9	65 - 69.9	70 - 74.9	75 - 79.9	80 - 84.9	85 - 89.9	OTHR	
<b>ROAD NAME: WADE ROAD</b>																		
ADT / BIN:		189	32	203	272	610	878	627	395	132	33	8	1	4	0	1	0	3385
% ADT / BIN:		6%	1%	8%	8%	19%	26%	19%	12%	4%	1%	0%	0%	0%	0%	0%	0%	100%
<b>AVERAGE SPEED: 40.8 MPH</b>		<b>50% SPEED: 42.2 MPH</b>						<b>85% SPEED: 50.9 MPH</b>										

Report Generated By: T. HOBSON  
12/30/2014

**ROAD NAME: NB WADE RD**

DATE	TIME	BIN 1	BIN 2	BIN 3	BIN 4	BIN 5	BIN 6	BIN 7	BIN 8	BIN 9	BIN 10	BIN 11	BIN 12	BIN 13	BIN 14	BIN 15	BIN 16	TOTAL
		MILE PER HOUR (MPH) RANGE																
		0 - 19.9	20 - 24.9	25 - 29.9	30 - 34.9	35 - 39.9	40 - 44.9	45 - 49.9	50 - 54.9	55 - 59.9	60 - 64.9	65 - 69.9	70 - 74.9	75 - 79.9	80 - 84.9	85 - 89.9	OTHR	
08/08/2012	09:00	8	1	6	11	7	34	8	1	0	0	0	0	0	0	0	0	76
	09:00	0	0	0	2	9	15	20	14	8	0	0	0	0	0	0	0	88
	10:00	10	1	6	8	16	17	6	1	0	0	0	0	0	0	0	0	85
	10:00	1	0	0	4	11	13	17	7	5	1	0	0	0	0	0	0	59
	11:00	10	2	7	5	16	17	6	0	0	0	0	0	0	0	0	0	83
	11:00	0	0	1	5	5	12	14	8	5	0	1	0	0	0	0	0	51
	12:00	9	2	6	6	13	24	3	0	0	0	0	0	0	0	0	0	63
	12:00	0	0	0	1	4	14	18	14	3	0	0	0	0	0	0	0	54
	13:00	7	2	6	12	17	19	6	0	0	0	0	0	0	0	0	0	89
	13:00	0	0	1	3	14	12	27	10	12	2	1	0	0	0	0	0	82
	14:00	8	1	17	13	24	24	7	0	0	0	0	0	0	0	0	0	94
	14:00	0	0	0	6	12	24	28	26	6	2	1	0	0	0	0	0	105
	15:00	8	3	4	9	8	15	3	1	0	0	0	0	0	0	0	0	51
	15:00	0	0	3	9	22	28	33	38	14	1	0	0	1	0	0	0	149
	16:00	9	0	5	7	23	23	3	1	0	0	0	0	0	0	1	0	72
	16:00	0	1	0	2	20	39	50	46	16	8	3	0	1	0	0	0	186
17:00	9	0	9	9	18	35	15	0	0	0	0	0	0	0	0	0	95	
17:00	1	0	1	3	30	43	59	59	20	4	0	0	0	0	0	0	220	
18:00	5	4	9	8	30	16	7	0	0	0	0	0	0	0	0	0	81	
18:00	1	1	1	6	23	29	61	44	12	3	0	0	0	0	0	0	181	
19:00	3	0	7	3	12	14	2	1	0	0	0	0	0	0	0	0	42	
19:00	0	0	1	10	25	39	44	19	7	1	0	0	0	0	0	0	146	
20:00	6	2	12	7	13	9	3	0	0	0	0	0	0	0	0	0	52	
20:00	0	0	1	7	17	29	22	22	5	1	0	0	0	0	0	0	104	
21:00	2	1	6	4	6	7	1	0	0	0	0	0	0	0	0	0	29	
21:00	0	2	1	4	12	24	22	19	6	1	0	0	0	0	0	0	81	
22:00	1	0	3	1	2	11	0	0	0	0	0	0	0	0	0	0	18	
22:00	0	0	0	2	17	9	21	7	2	0	0	0	0	0	0	0	58	
23:00	1	0	4	0	3	3	0	0	0	0	0	0	0	0	0	0	11	
23:00	0	0	0	3	6	6	3	6	2	3	0	1	0	0	0	0	30	
06/09/2012	00:00	0	0	0	2	0	1	1	0	0	0	0	0	0	0	0	0	4
06/09/2012	00:00	0	0	0	2	4	3	3	4	1	1	0	0	0	0	0	0	18
	01:00	1	0	1	1	0	2	0	0	0	0	0	0	0	0	0	0	5
	01:00	0	0	2	1	2	4	2	3	0	0	0	0	0	0	0	0	14
	02:00	1	0	2	0	0	1	1	0	0	0	0	0	0	0	0	0	5
	02:00	0	1	0	0	1	2	3	2	1	1	0	0	1	0	0	0	12
	03:00	1	0	2	2	2	2	0	0	0	0	0	0	0	0	0	0	11
	03:00	0	0	0	1	0	0	3	1	1	0	0	0	0	0	0	0	9
	04:00	5	1	3	4	8	12	1	3	0	0	0	0	0	0	0	0	37
	04:00	0	0	0	0	2	1	1	3	0	1	0	0	0	0	0	0	8
	05:00	13	0	7	14	17	25	12	0	0	0	0	0	0	0	0	0	88
	05:00	0	0	0	2	7	13	11	2	4	0	0	0	0	0	0	0	39
	06:00	27	1	17	23	34	47	10	1	0	0	0	0	0	0	0	0	160
	06:00	0	1	2	1	8	14	12	7	1	1	0	0	1	0	0	0	48
	07:00	25	4	28	25	47	72	14	0	0	0	0	0	0	0	0	0	215
	07:00	0	1	4	3	7	15	10	10	1	0	0	0	0	0	0	0	51
	08:00	17	0	14	18	30	38	13	1	0	0	2	0	0	0	0	0	134
	08:00	0	0	2	3	6	16	19	14	0	2	0	0	0	0	0	0	65
ADT / BIN:		189	32	203	272	610	878	627	395	132	33	8	1	4	0	1	0	3385
% ADT / BIN:		8%	1%	8%	8%	19%	26%	19%	12%	4%	1%	0%	0%	0%	0%	0%	0%	
<b>AVERAGE SPEED: 40.8 MPH</b>		<b>50% SPEED: 42.2 MPH</b>						<b>85% SPEED: 50.9 MPH</b>										

PIMA COUNTY DEPARTMENT OF TRANSPORTATION  
TRAFFIC ENGINEERING

SPEEDS FOR: WADE1  
LOCATION: 200' NORTH OF DOVEWOOD WAY  
BLOCK NUMBER: 7110 S

START: 09:00 on 08/08/12      END: 20:16 on 08/08/12

DATE	TIME	BIN 1	BIN 2	BIN 3	BIN 4	BIN 5	BIN 6	BIN 7	BIN 8	BIN 9	BIN 10	BIN 11	BIN 12	BIN 13	BIN 14	BIN 15	BIN 16	OTHR	TOTAL
		0 - 19.9	20 - 24.9	25 - 29.9	30 - 34.9	35 - 39.9	40 - 44.9	45 - 49.5	50 - 54.9	55 - 59.9	60 - 64.9	65 - 69.9	70 - 74.9	75 - 79.9	80 - 84.9	85 - 89.9			
<b>ROAD NAME: NB WADE RD</b>																			
VEH / BIN:		186	25	183	192	348	471	124	10	0	0	2	0	0	0	1	0		1540
% VEH / BIN:		12%	2%	12%	12%	22%	31%	8%	1%	0%	0%	0%	0%	0%	0%	0%	0%		100%
<b>AVERAGE SPEED: 34.6 MPH</b>		<b>50% SPEED: 37.7 MPH</b>					<b>85% SPEED: 44.0 MPH</b>												
<b>ROAD NAME: SB WADE RD</b>																			
VEH / BIN:		3	7	20	80	264	407	503	385	132	33	6	1	4	0	0	0		1845
% VEH / BIN:		0%	0%	1%	4%	14%	22%	27%	21%	7%	2%	0%	0%	0%	0%	0%	0%		100%
<b>AVERAGE SPEED: 46.0 MPH</b>		<b>50% SPEED: 46.6 MPH</b>					<b>85% SPEED: 53.6 MPH</b>												
<b>COMBINED TOTAL:</b>																			
ADT / BIN:		189	32	203	272	610	878	627	395	132	33	8	1	4	0	1	0		3385
% ADT / BIN:		8%	1%	8%	8%	18%	26%	19%	12%	4%	1%	0%	0%	0%	0%	0%	0%		100%
<b>AVERAGE SPEED: 40.8 MPH</b>		<b>50% SPEED: 42.2 MPH</b>					<b>85% SPEED: 50.9 MPH</b>												

Report Generated By: T. HOBSON  
12/30/2014

DATE	TIME	BIN 1	BIN 2	BIN 3	BIN 4	BIN 5	BIN 6	BIN 7	BIN 8	BIN 9	BIN 10	BIN 11	BIN 12	BIN 13	BIN 14	BIN 15	BIN 16	OTHR	TOTAL	
		0 - 19.9	20 - 24.9	25 - 29.9	30 - 34.9	35 - 39.9	40 - 44.9	45 - 49.5	50 - 54.9	55 - 59.9	60 - 64.9	65 - 69.9	70 - 74.9	75 - 79.9	80 - 84.9	85 - 89.9				
<b>ROAD NAME: NB WADE RD</b>																				
08/08/2012	9:00	6	1	6	11	7	34	8	1	0	0	0	0	0	0	0	0		76	
	10:00	10	1	6	8	16	17	6	1	0	0	0	0	0	0	0	0		65	
	11:00	10	2	7	5	16	17	6	0	0	0	0	0	0	0	0	0		63	
	12:00	9	2	6	6	13	24	3	0	0	0	0	0	0	0	0	0		63	
	13:00	7	2	6	12	17	19	6	0	0	0	0	0	0	0	0	0		89	
	14:00	8	1	17	13	24	24	7	0	0	0	0	0	0	0	0	0		94	
	15:00	8	3	4	9	8	15	3	1	0	0	0	0	0	0	0	0		51	
	16:00	9	0	5	7	23	23	3	1	0	0	0	0	0	0	0	1		72	
	17:00	9	0	9	9	18	35	15	0	0	0	0	0	0	0	0	0		95	
	18:00	5	4	9	8	30	18	7	0	0	0	0	0	0	0	0	0		81	
	19:00	3	0	7	3	12	14	2	1	0	0	0	0	0	0	0	0		42	
	20:00	8	2	12	7	13	9	3	0	0	0	0	0	0	0	0	0		52	
	21:00	2	1	8	4	6	7	1	0	0	0	0	0	0	0	0	0		29	
	22:00	1	0	3	1	2	11	0	0	0	0	0	0	0	0	0	0		18	
	23:00	1	0	4	0	3	3	0	0	0	0	0	0	0	0	0	0		11	
	08/09/2012	00:00	0	0	0	2	0	1	1	0	0	0	0	0	0	0	0	0		4
		01:00	1	0	1	1	0	2	0	0	0	0	0	0	0	0	0	0		5
02:00		1	0	2	0	0	1	1	0	0	0	0	0	0	0	0	0		5	
03:00		1	0	2	2	2	2	2	0	0	0	0	0	0	0	0	0		11	
04:00		5	1	3	4	8	12	1	3	0	0	0	0	0	0	0	0		37	
05:00		13	0	7	14	17	25	12	0	0	0	0	0	0	0	0	0		88	
06:00		27	1	17	23	34	47	10	1	0	0	0	0	0	0	0	0		160	
07:00		25	4	28	25	47	72	14	0	0	0	0	0	0	0	0	0		215	
0:00		0	0	0	0	0	0	0	0	0	0	0	0	0	0	0	0		0	
VEH / BIN:		186	25	183	192	346	471	124	10	0	0	2	0	0	0	1	0		1540	
% VEH / BIN:		12%	2%	12%	12%	22%	31%	8%	1%	0%	0%	0%	0%	0%	0%	0%	0%		100%	
<b>AVERAGE SPEED: 34.5 MPH</b>		<b>50% SPEED: 37.7 MPH</b>					<b>85% SPEED: 44.0 MPH</b>													

ROAD NAME: SB WADE RD



		BIN 1	BIN 2	BIN 3	BIN 4	BIN 5	BIN 6	BIN 7	BIN 8	BIN 9	BIN 10	BIN 11	BIN 12	BIN 13	BIN 14	BIN 15	BIN 16	TOTAL
		MILE PER HOUR (MPH) RANGE																
DATE	TIME	0 - 19.9	20 - 24.9	25 - 29.9	30 - 34.9	35 - 39.9	40 - 44.9	45 - 49.9	50 - 54.9	55 - 59.9	60 - 64.9	65 - 69.9	70 - 74.9	75 - 79.9	80 - 84.9	85 - 89.9	OTHR	TOTAL
08/08/2012	09:00	0	0	0	2	9	15	20	14	8	0	0	0	0	0	0	0	68
	10:00	1	0	0	4	11	13	17	7	5	1	0	0	0	0	0	0	59
	11:00	0	0	1	5	5	12	14	8	5	0	1	0	0	0	0	0	51
	12:00	0	0	0	1	4	14	18	14	3	0	0	0	0	0	0	0	54
	13:00	0	0	1	3	14	12	27	10	12	2	1	0	0	0	0	0	82
	14:00	0	0	0	6	12	24	28	26	6	2	1	0	0	0	0	0	105
	15:00	0	0	3	9	22	28	33	38	14	1	0	0	1	0	0	0	149
	16:00	0	1	0	2	20	39	50	46	16	8	3	0	1	0	0	0	185
	17:00	1	0	1	3	30	43	59	59	20	4	0	0	0	0	0	0	220
	18:00	1	1	1	5	23	29	61	44	12	3	0	0	0	0	0	0	181
	19:00	0	0	1	10	25	39	44	19	7	1	0	0	0	0	0	0	145
	20:00	0	0	1	7	17	29	22	22	5	1	0	0	0	0	0	0	104
	21:00	0	2	1	4	12	24	22	19	6	1	0	0	0	0	0	0	91
	22:00	0	0	0	2	17	9	21	7	2	0	0	0	0	0	0	0	58
23:00	0	0	0	3	6	6	3	6	2	3	0	1	0	0	0	0	30	
08/09/2012	00:00	0	0	0	2	4	3	3	4	1	1	0	0	0	0	0	0	18
	01:00	0	0	2	1	2	4	2	3	0	0	0	0	0	0	0	0	14
	02:00	0	1	0	0	1	2	3	2	1	1	0	0	1	0	0	0	12
	03:00	0	0	0	1	0	0	3	1	1	0	0	0	0	0	0	0	6
	04:00	0	0	0	0	2	1	1	3	0	1	0	0	0	0	0	0	8
	05:00	0	0	0	2	7	13	11	2	4	0	0	0	0	0	0	0	39
	06:00	0	1	2	1	8	14	12	7	1	1	0	0	1	0	0	0	48
	07:00	0	0	0	0	0	0	0	0	0	0	0	0	0	0	0	0	0
	08:00	0	0	0	0	0	0	0	0	0	0	0	0	0	0	0	0	0
	09:00	0	0	0	0	0	0	0	0	0	0	0	0	0	0	0	0	0
VEH / BIN:		3	7	20	80	264	407	503	385	132	33	6	1	4	0	0	0	1845
% VEH / BIN:		0%	0%	1%	4%	14%	22%	27%	21%	7%	2%	0%	0%	0%	0%	0%	0%	
<b>AVERAGE SPEED: 46.0 MPH</b>		<b>50% SPEED: 43.5 MPH</b>						<b>85% SPEED: 53.6 MPH</b>										

Pima County Department of Transportation

Traffic Engineering Division

Turning Movement Counts

OCTOBER 21, 2014

Valencia Rd @ Wade Rd

File Name : ValenciaRd@WadeRd 102114

Site Code : 00000000

Start Date : 10/21/2014

Page No : 1

Groups Printed- Unshifted

Start Time	WADE RD SB				VALENCIA RD WB				WADE RD NB				VALENCIA RD EB				Int. Total
	Left	Thru	Right	App. Total	Left	Thru	Right	App. Total	Left	Thru	Right	App. Total	Left	Thru	Right	App. Total	
07:00 AM	0	0	0	0	27	41	0	68	7	0	186	193	0	150	5	155	416
07:15 AM	0	0	0	0	23	45	0	68	9	0	178	187	0	162	8	170	425
07:30 AM	0	0	0	0	56	27	0	83	3	0	163	166	0	137	22	159	408
07:45 AM	0	0	0	0	62	38	0	100	14	0	146	160	0	116	38	154	414
Total	0	0	0	0	168	151	0	319	33	0	673	706	0	565	73	638	1663
08:00 AM	0	0	0	0	68	31	0	99	23	0	167	190	0	90	18	108	397
08:15 AM	0	0	0	0	32	35	0	67	6	0	106	112	0	102	2	104	283
08:30 AM	0	0	0	0	34	49	0	83	0	0	81	81	0	87	4	91	255
08:45 AM	0	0	0	0	31	26	0	57	5	0	82	87	0	93	0	93	237
Total	0	0	0	0	165	141	0	306	34	0	436	470	0	372	24	396	1172
*** BREAK ***																	
02:00 PM	0	0	0	0	34	66	0	100	5	0	33	38	0	49	3	52	190
02:15 PM	0	0	0	0	53	83	0	136	6	0	49	55	0	67	4	71	262
02:30 PM	0	0	0	0	44	77	0	121	4	0	47	51	0	64	0	64	236
02:45 PM	0	0	0	0	67	85	0	152	2	0	40	42	0	77	8	85	279
Total	0	0	0	0	198	311	0	509	17	0	169	186	0	257	15	272	967
03:00 PM	0	0	0	0	72	86	0	158	0	0	38	38	0	69	8	77	273
03:15 PM	0	0	0	0	101	78	0	179	2	0	47	49	0	59	15	74	302
03:30 PM	0	0	0	0	130	86	0	216	6	0	48	54	0	59	16	75	345
03:45 PM	0	0	0	0	99	114	0	213	41	0	102	143	0	53	6	59	415
Total	0	0	0	0	402	364	0	766	49	0	235	284	0	240	45	285	1335
04:00 PM	0	0	0	0	92	107	0	199	13	0	45	58	0	58	7	65	322
04:15 PM	0	0	0	0	92	107	0	199	7	0	53	60	0	45	9	54	313
04:30 PM	0	0	0	0	105	110	0	215	3	0	47	50	0	65	3	68	333
04:45 PM	0	0	0	0	84	135	0	219	3	0	57	60	0	77	5	82	361
Total	0	0	0	0	373	459	0	832	26	0	202	228	0	245	24	269	1329
05:00 PM	0	0	0	0	104	119	0	223	5	0	60	65	0	67	9	76	364
05:15 PM	0	0	0	0	143	145	0	288	6	0	56	62	0	85	11	96	446
05:30 PM	0	0	0	0	130	117	0	247	5	0	70	75	0	49	2	51	373
05:45 PM	0	0	0	0	126	159	0	285	6	0	52	58	0	59	9	68	411
Total	0	0	0	0	503	540	0	1043	22	0	238	260	0	260	31	291	1594
Grand Total	0	0	0	0	1809	1966	0	3775	181	0	1953	2134	0	1939	212	2151	8060
Apprch %	0	0	0	0	47.9	52.1	0		8.5	0	91.5		0	90.1	9.9		
Total %	0	0	0	0	22.4	24.4	0	46.8	2.2	0	24.2	26.5	0	24.1	2.6	26.7	

Pima County Department of Transportation

Traffic Engineering Division

Turning Movement Counts

**OCTOBER 21, 2014**

**Valencia Rd @ Wade Rd**

File Name : ValenciaRd@WadeRd 102114

Site Code : 00000000

Start Date : 10/21/2014

Page No : 2

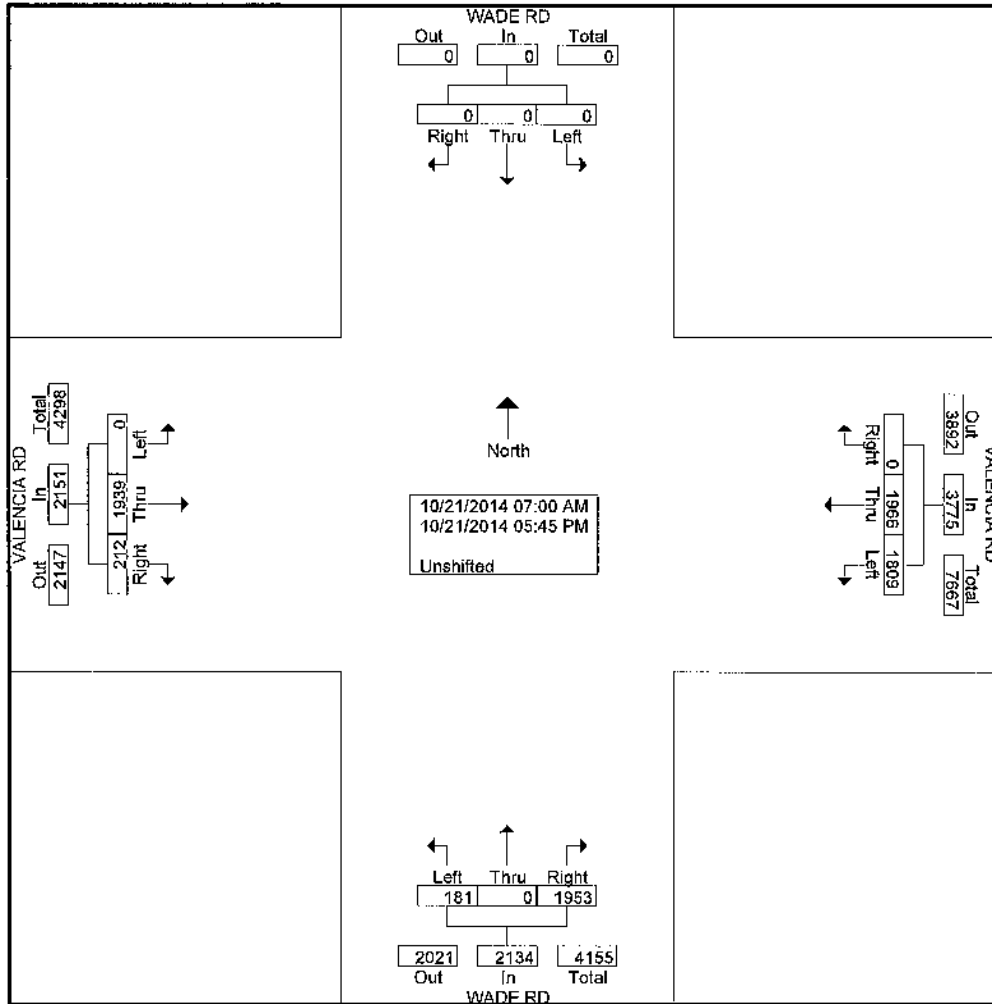

Pima County Department of Transportation

Traffic Engineering Division

Turning Movement Counts

OCTOBER 21, 2014

Valencia Rd @ Wade Rd

File Name : ValenciaRd@WadeRd 102114

Site Code : 00000000

Start Date : 10/21/2014

Page No : 3

Start Time	WADE RD SB				VALENCIA RD WB				WADE RD NB				VALENCIA RD EB				Int. Total
	Left	Thru	Right	App. Total	Left	Thru	Right	App. Total	Left	Thru	Right	App. Total	Left	Thru	Right	App. Total	
Peak Hour Analysis From 07:00 AM to 08:45 AM - Peak 1 of 1																	
Peak Hour for Entire Intersection Begins at 07:00 AM																	
07:00 AM	0	0	0	0	27	41	0	68	7	0	186	193	0	150	5	155	416
07:15 AM	0	0	0	0	23	45	0	68	9	0	178	187	0	162	8	170	425
07:30 AM	0	0	0	0	56	27	0	83	3	0	163	166	0	137	22	159	408
07:45 AM	0	0	0	0	62	38	0	100	14	0	146	160	0	116	38	154	414
Total Volume	0	0	0	0	168	151	0	319	33	0	673	706	0	565	73	638	1663
% App. Total	0	0	0	0	52.7	47.3	0		4.7	0	95.3		0	88.6	11.4		
PHF	.000	.000	.000	.000	.677	.839	.000	.798	.589	.000	.905	.915	.000	.872	.480	.938	.978

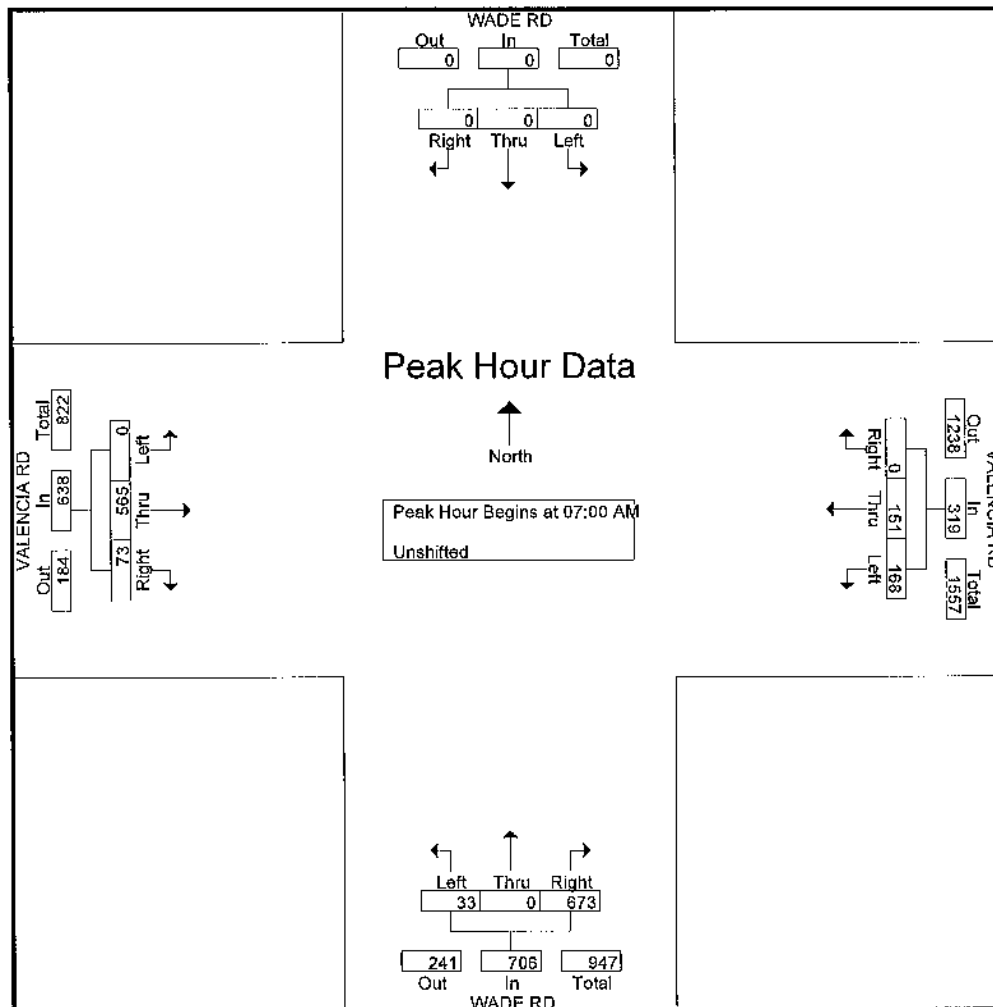

Pima County Department of Transportation

Traffic Engineering Division

Turning Movement Counts

**OCTOBER 21, 2014**

**Valencia Rd @ Wade Rd**

File Name : ValenciaRd@WadeRd 102114

Site Code : 00000000

Start Date : 10/21/2014

Page No : 4

Start Time	WADE RD SB				VALENCIA RD WB				WADE RD NB				VALENCIA RD EB				Int. Total
	Left	Thru	Right	App. Total	Left	Thru	Right	App. Total	Left	Thru	Right	App. Total	Left	Thru	Right	App. Total	
Peak Hour Analysis From 02:00 PM to 03:45 PM - Peak 1 of 1																	
Peak Hour for Entire Intersection Begins at 03:00 PM																	
03:00 PM	0	0	0	0	72	86	0	158	0	0	38	38	0	69	8	77	273
03:15 PM	0	0	0	0	101	78	0	179	2	0	47	49	0	59	15	74	302
03:30 PM	0	0	0	0	130	86	0	216	6	0	48	54	0	59	16	75	345
03:45 PM	0	0	0	0	99	114	0	213	41	0	102	143	0	53	6	59	415
Total Volume	0	0	0	0	402	364	0	766	49	0	235	284	0	240	45	285	1335
% App. Total	0	0	0	0	52.5	47.5	0		17.3	0	82.7		0	84.2	15.8		
PHF	.000	.000	.000	.000	.773	.798	.000	.887	.299	.000	.576	.497	.000	.870	.703	.925	.804

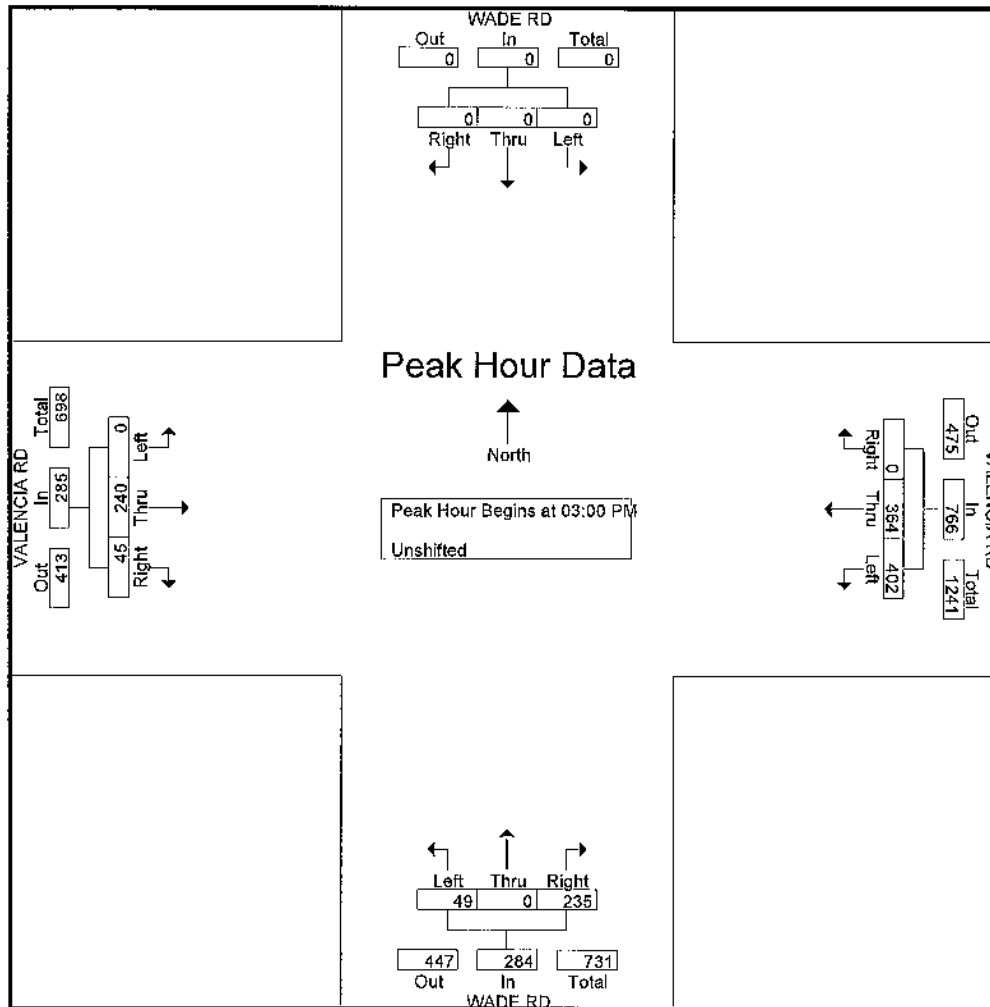

Pima County Department of Transportation

Traffic Engineering Division

Turning Movement Counts

**OCTOBER 21, 2014**

**Valencia Rd @ Wade Rd**

File Name : ValenciaRd@WadeRd 102114

Site Code : 00000000

Start Date : 10/21/2014

Page No : 5

Start Time	WADE RD SB				VALENCIA RD WB				WADE RD NB				VALENCIA RD EB				Int. Total
	Left	Thru	Right	App. Total	Left	Thru	Right	App. Total	Left	Thru	Right	App. Total	Left	Thru	Right	App. Total	
Peak Hour Analysis From 04:00 PM to 05:45 PM - Peak 1 of 1																	
Peak Hour for Entire Intersection Begins at 05:00 PM																	
05:00 PM	0	0	0	0	104	119	0	223	5	0	60	65	0	67	9	76	364
05:15 PM	0	0	0	0	143	145	0	288	6	0	56	62	0	85	11	96	446
05:30 PM	0	0	0	0	130	117	0	247	5	0	70	75	0	49	2	51	373
05:45 PM	0	0	0	0	126	159	0	285	6	0	52	58	0	59	9	68	411
Total Volume	0	0	0	0	503	540	0	1043	22	0	238	260	0	260	31	291	1594
% App. Total	0	0	0	0	48.2	51.8	0		8.5	0	91.5		0	89.3	10.7		
PHF	.000	.000	.000	.000	.879	.849	.000	.905	.917	.000	.850	.867	.000	.765	.705	.758	.893

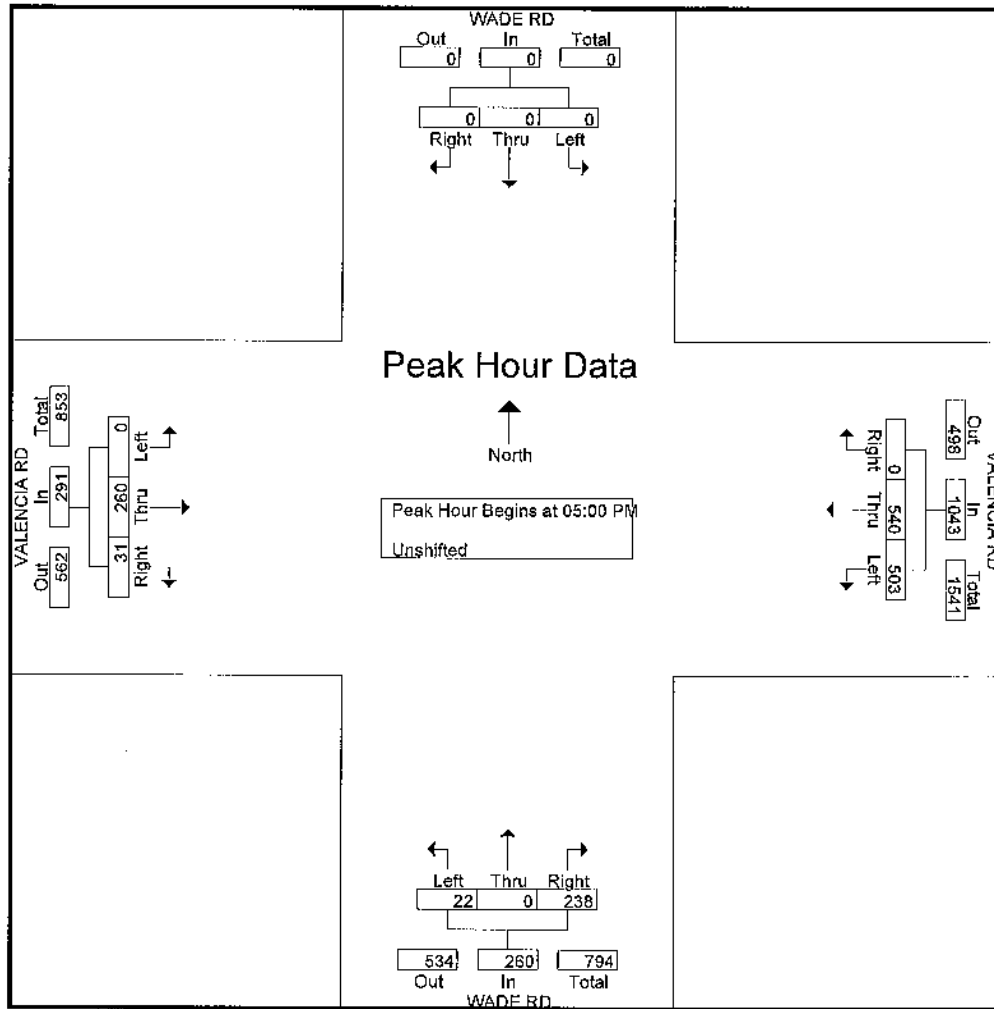

Pima County Department of Transportation

Traffic Engineering Division

Turning Movement Counts

OCTOBER 21, 2014

Camino Verde @ Valencia Rd

File Name : caminoverde@valenciard 102114

Site Code : 00000000

Start Date : 10/21/2014

Page No : 1

Groups Printed- Unshifted

Start Time	CAMINO VERDE SB				VALENCIA RD WB				CAMINO VERDE NB				VALENCIA RD EB				Int. Total
	Left	Thru	Right	App. Total	Left	Thru	Right	App. Total	Left	Thru	Right	App. Total	Left	Thru	Right	App. Total	
07:00 AM	22	0	17	39	0	46	3	49	0	0	0	0	118	182	0	300	388
07:15 AM	26	0	26	52	0	51	8	59	0	0	0	0	125	199	0	324	435
07:30 AM	31	0	31	62	0	52	9	61	0	0	0	0	126	191	0	317	440
07:45 AM	27	0	45	72	0	80	8	88	0	0	0	0	101	166	0	267	427
Total	106	0	119	225	0	229	28	257	0	0	0	0	470	738	0	1208	1690
08:00 AM	20	0	25	45	0	67	11	78	0	0	0	0	115	167	0	282	405
08:15 AM	21	0	25	46	0	46	12	58	0	0	0	0	73	137	0	210	314
08:30 AM	23	0	29	52	0	43	4	47	0	0	0	0	54	99	0	153	252
08:45 AM	21	0	15	36	0	46	18	64	0	0	0	0	62	90	0	152	252
Total	85	0	94	179	0	202	45	247	0	0	0	0	304	493	0	797	1223
*** BREAK ***																	
04:00 PM	18	0	82	100	0	113	32	145	0	0	0	0	27	63	0	90	335
04:15 PM	20	0	68	88	0	115	31	146	0	0	0	0	38	66	0	104	338
04:30 PM	22	0	64	86	0	144	39	183	0	0	0	0	39	71	0	110	379
04:45 PM	15	0	86	101	0	126	41	167	0	0	0	0	49	77	0	126	394
Total	75	0	300	375	0	498	143	641	0	0	0	0	153	277	0	430	1446
05:00 PM	22	0	74	96	0	161	38	199	0	0	0	0	45	93	0	138	433
05:15 PM	16	0	109	125	0	177	29	206	0	0	0	0	33	89	1	123	454
05:30 PM	20	0	110	130	0	128	33	161	0	0	0	0	45	95	0	140	431
05:45 PM	17	0	115	132	0	161	23	184	0	0	0	0	25	68	0	93	409
Total	75	0	408	483	0	627	123	750	0	0	0	0	148	345	1	494	1727
Grand Total	341	0	921	1262	0	1556	339	1895	0	0	0	0	1075	1853	1	2929	6086
Apprch %	27	0	73		0	82.1	17.9		0	0	0		36.7	63.3	0		
Total %	5.6	0	15.1	20.7	0	25.6	5.6	31.1	0	0	0	0	17.7	30.4	0	48.1	

Pima County Department of Transportation

Traffic Engineering Division

Turning Movement Counts

OCTOBER 21, 2014

Camino Verde @ Valencia Rd

File Name : caminoverde@valenciard 102114

Site Code : 00000000

Start Date : 10/21/2014

Page No : 2

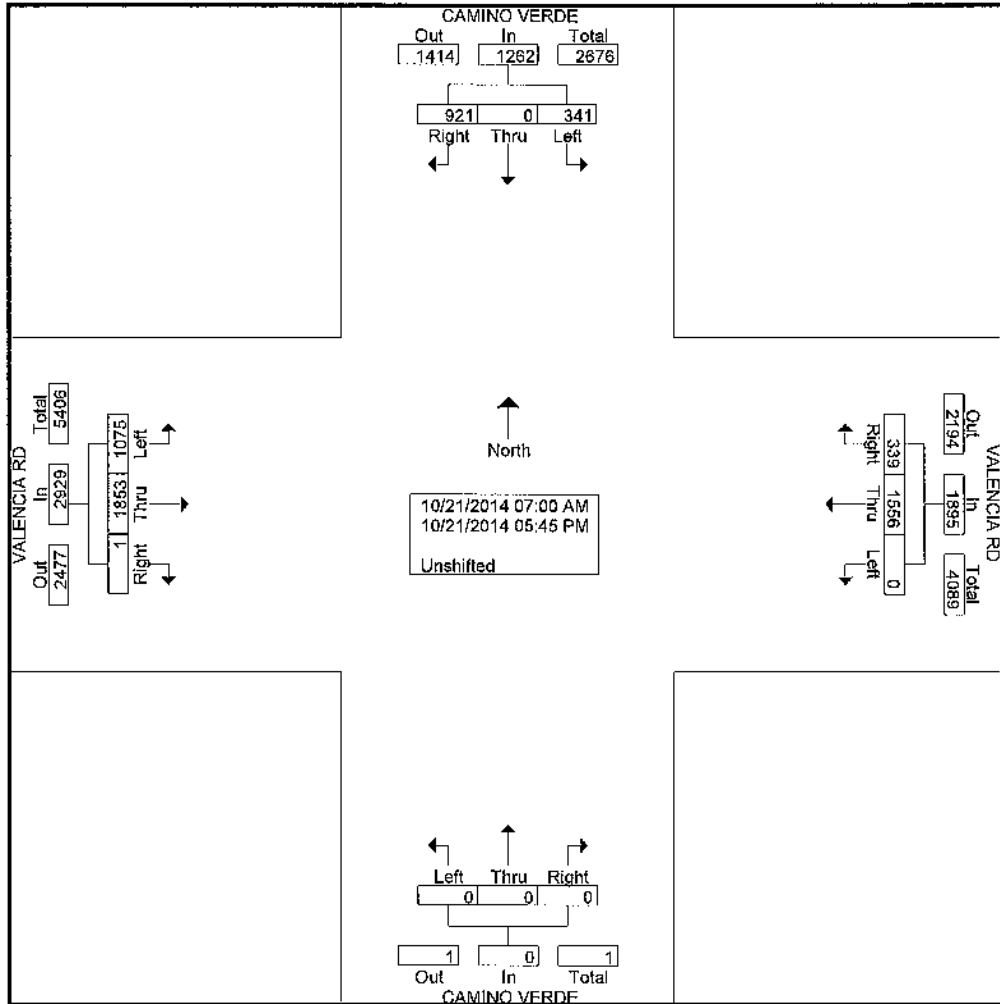



Pima County Department of Transportation

Traffic Engineering Division

Turning Movement Counts

OCTOBER 21, 2014

Camino Verde @ Valencia Rd

File Name : caminoverde@valenciard 102114

Site Code : 00000000

Start Date : 10/21/2014

Page No : 3

Start Time	CAMINO VERDE SB				VALENCIA RD WB				CAMINO VERDE NB				VALENCIA RD EB				Int. Total
	Left	Thru	Right	App. Total	Left	Thru	Right	App. Total	Left	Thru	Right	App. Total	Left	Thru	Right	App. Total	
Peak Hour Analysis From 07:00 AM to 08:45 AM - Peak 1 of 1																	
Peak Hour for Entire Intersection Begins at 07:15 AM																	
07:15 AM	26	0	26	52	0	51	8	59	0	0	0	0	125	199	0	324	435
07:30 AM	31	0	31	62	0	52	9	61	0	0	0	0	126	191	0	317	440
07:45 AM	27	0	45	72	0	80	8	88	0	0	0	0	101	166	0	267	427
08:00 AM	20	0	25	45	0	67	11	78	0	0	0	0	115	167	0	282	405
Total Volume	104	0	127	231	0	250	36	286	0	0	0	0	467	723	0	1190	1707
% App. Total	45	0	55		0	87.4	12.6		0	0	0		39.2	60.8	0		
PHF	.839	.000	.706	.802	.000	.781	.818	.813	.000	.000	.000	.000	.927	.908	.000	.918	.970

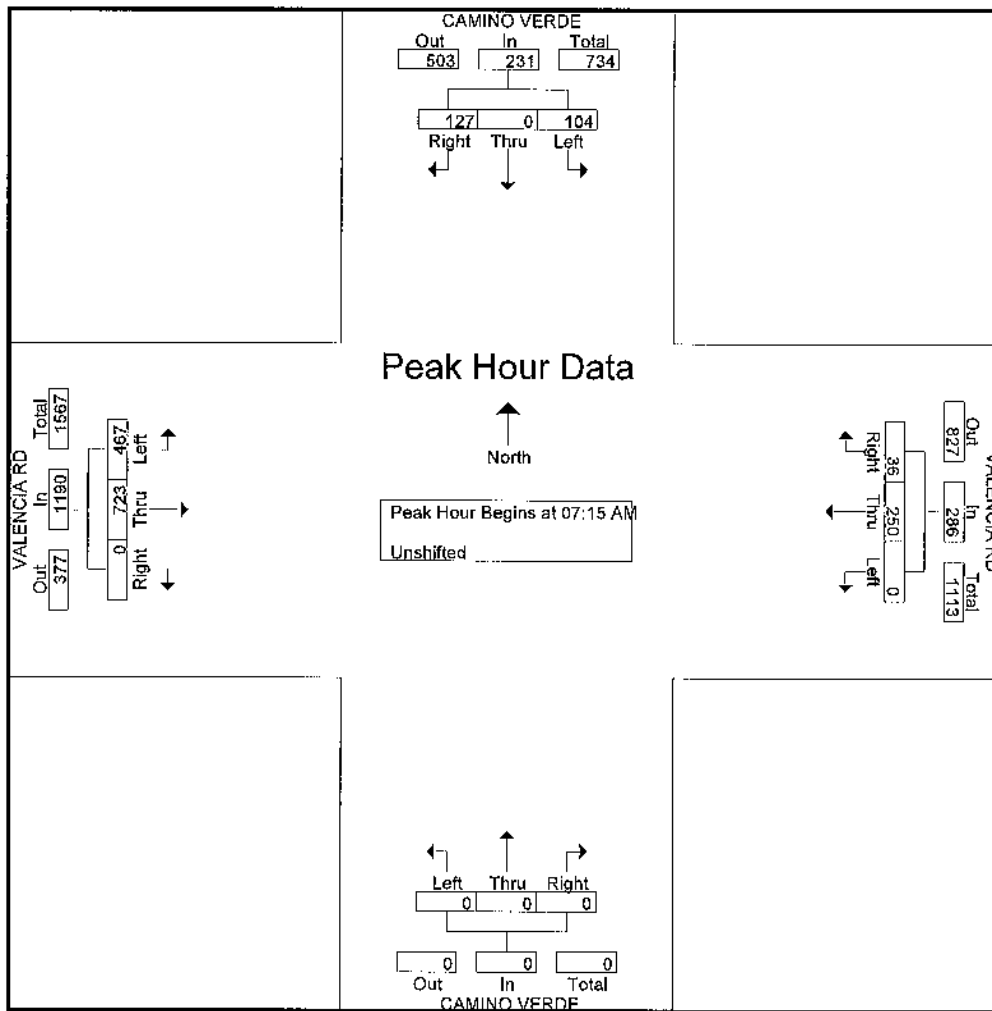

**Pima County Department of Transportation**  
 Traffic Engineering Division  
 Turning Movement Counts  
**OCTOBER 21, 2014**  
**Camino Verde @ Valencia Rd**

File Name : caminoverde@valenciard 102114  
 Site Code : 00000000  
 Start Date : 10/21/2014  
 Page No : 4

Start Time	CAMINO VERDE SB				VALENCIA RD WB				CAMINO VERDE NB				VALENCIA RD EB				Int. Total	
	Left	Thru	Right	App. Total	Left	Thru	Right	App. Total	Left	Thru	Right	App. Total	Left	Thru	Right	App. Total		
Peak Hour Analysis From 02:00 PM to 03:45 PM - Peak 1 of 1																		
Peak Hour for Entire Intersection Begins at 02:00 PM																		
02:00 PM	0	0	0	0	0	0	0	0	0	0	0	0	0	0	0	0	0	0
02:15 PM	0	0	0	0	0	0	0	0	0	0	0	0	0	0	0	0	0	0
02:30 PM	0	0	0	0	0	0	0	0	0	0	0	0	0	0	0	0	0	0
02:45 PM	0	0	0	0	0	0	0	0	0	0	0	0	0	0	0	0	0	0
Total Volume	0	0	0	0	0	0	0	0	0	0	0	0	0	0	0	0	0	0
% App. Total	0	0	0	0	0	0	0	0	0	0	0	0	0	0	0	0	0	0
PHF	.000	.000	.000	.000	.000	.000	.000	.000	.000	.000	.000	.000	.000	.000	.000	.000	.000	.000

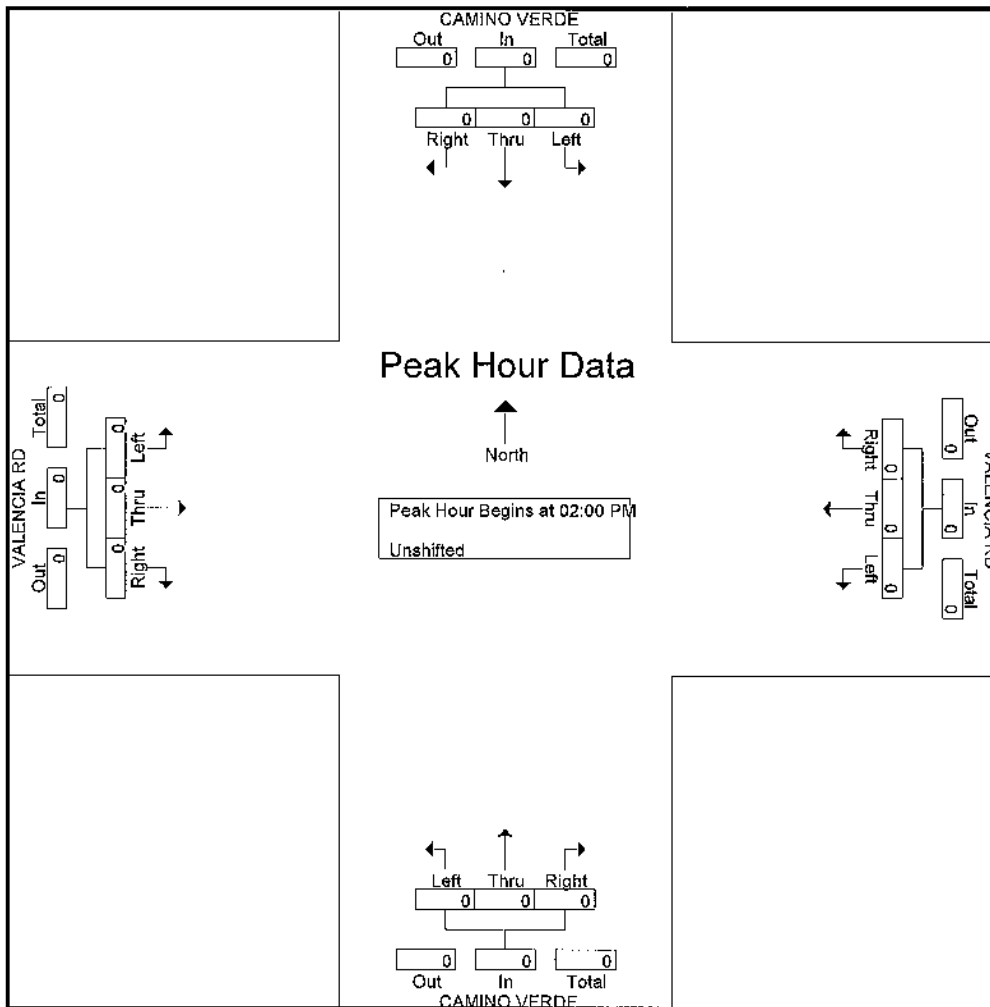

Pima County Department of Transportation

Traffic Engineering Division

Turning Movement Counts

**OCTOBER 21, 2014**

**Camino Verde @ Valencia Rd**

File Name : caminoverde@valenciard 102114

Site Code : 00000000

Start Date : 10/21/2014

Page No : 5

Start Time	CAMINO VERDE SB				VALENCIA RD WB				CAMINO VERDE NB				VALENCIA RD EB				Int. Total
	Left	Thru	Right	App. Total	Left	Thru	Right	App. Total	Left	Thru	Right	App. Total	Left	Thru	Right	App. Total	
Peak Hour Analysis From 04:00 PM to 05:45 PM - Peak 1 of 1																	
Peak Hour for Entire Intersection Begins at 05:00 PM																	
05:00 PM	22	0	74	96	0	161	38	199	0	0	0	0	45	93	0	138	433
05:15 PM	16	0	109	125	0	177	29	206	0	0	0	0	33	89	1	123	454
05:30 PM	20	0	110	130	0	128	33	161	0	0	0	0	45	95	0	140	431
05:45 PM	17	0	115	132	0	161	23	184	0	0	0	0	25	68	0	93	409
Total Volume	75	0	408	483	0	627	123	750	0	0	0	0	148	345	1	494	1727
% App. Total	15.5	0	84.5		0	83.6	16.4		0	0	0		30	69.8	0.2		
PHF	.852	.000	.887	.915	.000	.886	.809	.910	.000	.000	.000	.000	.822	.908	.250	.882	.951

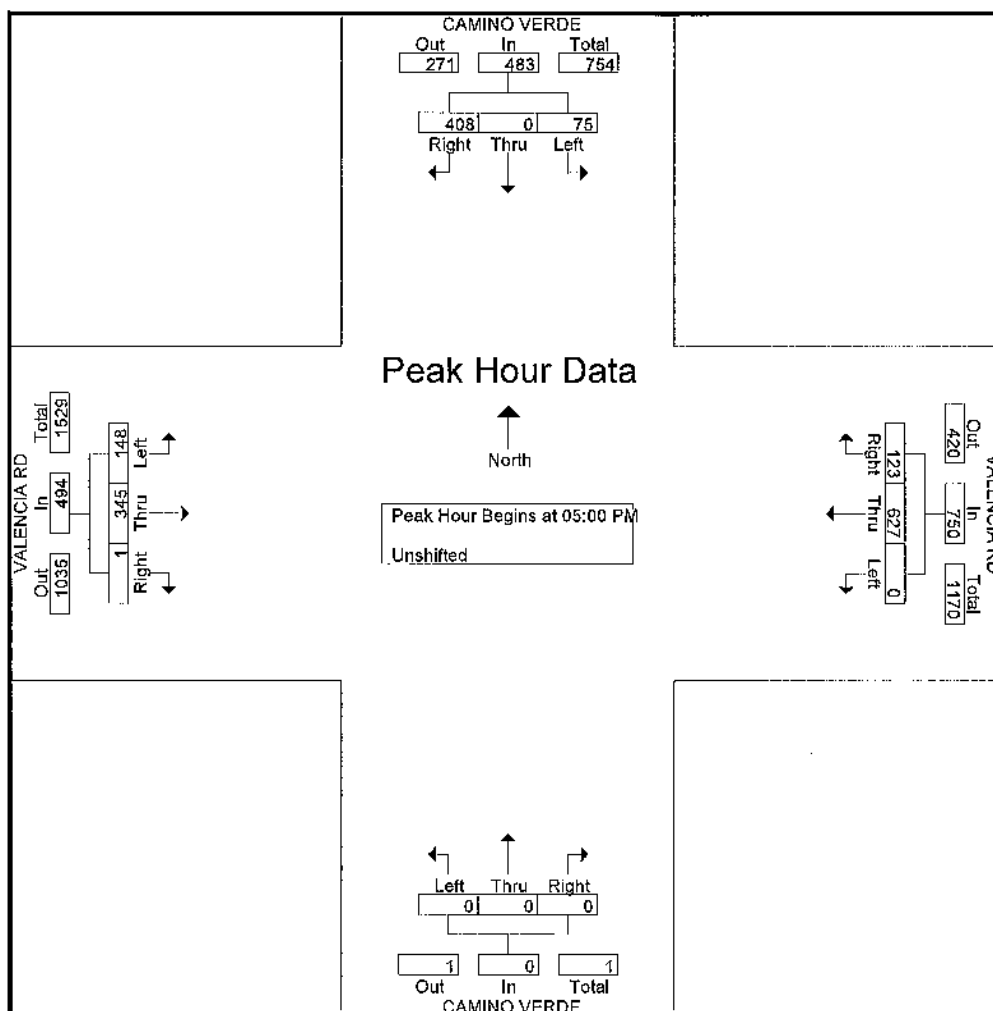

HCM Signalized Intersection Capacity Analysis  
 3: Camino Verde & Valencia Road

8/17/2015

Movement	EBL	EBT	EBR	WBL	WBT	WBR	NBL	NBT	NBR	SBL	SBT	SBR
Lane Configurations												
Traffic Volume (vph)	308	555	0	35	194	28	4	162	183	106	16	103
Future Volume (vph)	308	555	0	35	194	28	4	162	183	106	16	103
Ideal Flow (vphpl)	1900	1900	1900	1900	1900	1900	1900	1900	1900	1900	1900	1900
Total Lost time (s)	4.5	4.5		4.5	4.5	4.5	4.5	4.5	4.5	4.5	4.5	
Lane Util. Factor	1.00	0.95		1.00	0.95	1.00	1.00	1.00	1.00	1.00	1.00	
Frt	1.00	1.00		1.00	1.00	0.85	1.00	1.00	0.85	1.00	0.87	
Flt Protected	0.95	1.00		0.95	1.00	1.00	0.95	1.00	1.00	0.95	1.00	
Satd. Flow (prot)	1770	3539		1770	3539	1583	1770	1863	1583	1770	1620	
Flt Permitted	0.62	1.00		0.30	1.00	1.00	0.67	1.00	1.00	0.63	1.00	
Satd. Flow (perm)	1154	3539		550	3539	1583	1256	1863	1583	1169	1620	
Peak-hour factor, PHF	0.92	0.92	0.92	0.92	0.92	0.92	0.92	0.92	0.92	0.92	0.92	0.92
Adj. Flow (vph)	335	603	0	38	211	30	4	176	199	115	17	112
RTOR Reduction (vph)	0	0	0	0	0	22	0	0	142	0	80	0
Lane Group Flow (vph)	335	603	0	38	211	8	4	176	57	115	49	0
Turn Type	pm+pt	NA		pm+pt	NA	Perm	pm+pt	NA	Perm	pm+pt	NA	
Protected Phases	7	4		3	8		5	2		1	6	
Permitted Phases	4			8		8	2		2	6		
Actuated Green, G (s)	24.0	18.5		23.0	18.0	18.0	23.5	18.5	18.5	23.5	18.5	
Effective Green, g (s)	24.0	18.5		23.0	18.0	18.0	23.5	18.5	18.5	23.5	18.5	
Actuated g/C Ratio	0.37	0.28		0.35	0.28	0.28	0.36	0.28	0.28	0.36	0.28	
Clearance Time (s)	4.5	4.5		4.5	4.5	4.5	4.5	4.5	4.5	4.5	4.5	
Lane Grp Cap (vph)	478	1007		288	980	438	493	530	450	468	461	
v/s Ratio Prot	c0.06	0.17		0.01	0.06		0.00	c0.09		c0.02	0.03	
v/s Ratio Perm	c0.20			0.04		0.01	0.00		0.04	0.07		
v/c Ratio	0.70	0.60		0.13	0.22	0.02	0.01	0.33	0.13	0.25	0.11	
Uniform Delay, d1	18.2	20.0		18.2	18.1	17.1	13.3	18.4	17.3	15.0	17.2	
Progression Factor	1.00	1.00		1.00	1.00	1.00	1.00	1.00	1.00	1.00	1.00	
Incremental Delay, d2	8.3	2.6		0.9	0.5	0.1	0.0	1.7	0.6	1.2	0.5	
Delay (s)	26.5	22.7		19.1	18.6	17.2	13.3	20.0	17.8	16.3	17.6	
Level of Service	C	C		B	B	B	B	C	B	B	B	
Approach Delay (s)		24.1			18.5			18.8			17.0	
Approach LOS		C			B			B			B	

Intersection Summary

HCM 2000 Control Delay	21.2	HCM 2000 Level of Service	C
HCM 2000 Volume to Capacity ratio	0.51		
Actuated Cycle Length (s)	65.0	Sum of lost time (s)	18.0
Intersection Capacity Utilization	51.8%	ICU Level of Service	A
Analysis Period (min)	15		
c Critical Lane Group			

# HCM Signalized Intersection Capacity Analysis

## 6: Wade Road & Valencia Road

8/17/2015

	↶	→	↷	↶	←	↷	↶
Movement	EBU	EBT	EBR	WBL	WBT	NBL	NBR
Lane Configurations	↶	↶↶	↶	↶	↶↶	↶	↶
Traffic Volume (vph)	1	565	73	117	155	29	328
Future Volume (vph)	1	565	73	117	155	29	328
Ideal Flow (vphpl)	1900	1900	1900	1900	1900	1900	1900
Total Lost time (s)	4.5	4.5	4.5	4.5	4.5	4.5	4.5
Lane Util. Factor	1.00	0.95	1.00	1.00	0.95	1.00	1.00
Frt	1.00	1.00	0.85	1.00	1.00	1.00	0.85
Flt Protected	0.95	1.00	1.00	0.95	1.00	0.95	1.00
Satd. Flow (prot)	1770	3539	1583	1770	3539	1770	1583
Flt Permitted	0.63	1.00	1.00	0.40	1.00	0.95	1.00
Satd. Flow (perm)	1173	3539	1583	746	3539	1770	1583
Peak-hour factor, PHF	0.94	0.94	0.94	0.80	0.80	0.91	0.91
Adj. Flow (vph)	1	601	78	146	194	32	360
RTOR Reduction (vph)	0	0	52	0	0	0	259
Lane Group Flow (vph)	1	601	26	146	194	32	101
Turn Type	Perm	NA	Perm	pm+pt	NA	Prot	Perm
Protected Phases		4		3	8	2	
Permitted Phases	4		4	8			2
Actuated Green, G (s)	13.0	13.0	13.0	21.6	21.6	8.2	8.2
Effective Green, g (s)	13.0	13.0	13.0	21.6	21.6	8.2	8.2
Actuated g/C Ratio	0.34	0.34	0.34	0.56	0.56	0.21	0.21
Clearance Time (s)	4.5	4.5	4.5	4.5	4.5	4.5	4.5
Vehicle Extension (s)	3.0	3.0	3.0	3.0	3.0	3.0	3.0
Lane Grp Cap (vph)	393	1185	530	523	1970	374	334
v/s Ratio Prot		c0.17		c0.03	0.05	0.02	
v/s Ratio Perm	0.00		0.02	0.13			c0.06
w/c Ratio	0.00	0.51	0.05	0.28	0.10	0.09	0.30
Uniform Delay, d1	8.6	10.3	8.7	5.2	4.0	12.3	12.9
Progression Factor	1.00	1.00	1.00	1.00	1.00	1.00	1.00
Incremental Delay, d2	0.0	0.3	0.0	0.3	0.0	0.1	0.5
Delay (s)	8.6	10.7	8.8	5.5	4.1	12.4	13.4
Level of Service	A	B	A	A	A	B	B
Approach Delay (s)		10.5			4.7	13.3	
Approach LOS		B			A	B	

### Intersection Summary

HCM 2000 Control Delay	9.9	HCM 2000 Level of Service	A
HCM 2000 Volume to Capacity ratio	0.42		
Actuated Cycle Length (s)	38.8	Sum of lost time (s)	13.5
Intersection Capacity Utilization	43.4%	ICU Level of Service	A
Analysis Period (min)	15		

c Critical Lane Group

# HCM Signalized Intersection Capacity Analysis

## 3: Camino Verde & Valencia Road

8/17/2015

Movement	EBL	EBT	EBR	WBL	WBT	WBR	NBL	NBT	NBR	SBL	SBT	SBR
Lane Configurations												
Traffic Volume (vph)	93	243	2	198	429	123	3	55	102	75	179	229
Future Volume (vph)	93	243	2	198	429	123	3	55	102	75	179	229
Ideal Flow (vphpl)	1900	1900	1900	1900	1900	1900	1900	1900	1900	1900	1900	1900
Total Lost time (s)	4.5	4.5		4.5	4.5	4.5	4.5	4.5	4.5	4.5	4.5	
Lane Util. Factor	1.00	0.95		1.00	0.95	1.00	1.00	1.00	1.00	1.00	1.00	
Fr't	1.00	1.00		1.00	1.00	0.85	1.00	1.00	0.85	1.00	0.92	
Flt Protected	0.95	1.00		0.95	1.00	1.00	0.95	1.00	1.00	0.95	1.00	
Satd. Flow (prot)	1770	3535		1770	3539	1583	1770	1863	1583	1770	1706	
Flt Permitted	0.40	1.00		0.58	1.00	1.00	0.22	1.00	1.00	0.72	1.00	
Satd. Flow (perm)	749	3535		1082	3539	1583	401	1863	1583	1337	1706	
Peak-hour factor, PHF	0.88	0.88	0.88	0.91	0.91	0.91	0.92	0.92	0.92	0.91	0.91	0.91
Adj. Flow (vph)	106	276	2	218	471	135	3	60	111	82	197	252
RTOR Reduction (vph)	0	1	0	0	0	98	0	0	79	0	71	0
Lane Group Flow (vph)	106	277	0	218	471	37	3	60	32	82	378	0
Turn Type	pm+pt	NA		pm+pt	NA	Perm	pm+pt	NA	Perm	pm+pt	NA	
Protected Phases	7	4		3	8		5	2		1	6	
Permitted Phases	4			8		8	2		2	6		
Actuated Green, G (s)	23.2	18.1		23.0	18.0	18.0	23.9	18.9	18.9	23.9	18.9	
Effective Green, g (s)	23.2	18.1		23.0	18.0	18.0	23.9	18.9	18.9	23.9	18.9	
Actuated g/C Ratio	0.36	0.28		0.35	0.28	0.28	0.37	0.29	0.29	0.37	0.29	
Clearance Time (s)	4.5	4.5		4.5	4.5	4.5	4.5	4.5	4.5	4.5	4.5	
Lane Grp Cap (vph)	347	984		435	980	438	252	541	460	524	496	
v/s Ratio Prot	0.02	0.08		c0.04	0.13		0.00	0.03		c0.01	c0.22	
v/s Ratio Perm	0.08			c0.14		0.02	0.00		0.02	0.05		
v/c Ratio	0.31	0.28		0.50	0.48	0.09	0.01	0.11	0.07	0.16	0.76	
Uniform Delay, d1	17.5	18.4		17.0	19.6	17.4	20.8	16.9	16.7	13.8	21.0	
Progression Factor	1.00	1.00		1.00	1.00	1.00	1.00	1.00	1.00	1.00	1.00	
Incremental Delay, d2	2.3	0.7		4.1	1.7	0.4	0.1	0.4	0.3	0.6	10.6	
Delay (s)	19.8	19.1		21.1	21.3	17.8	20.9	17.3	17.0	14.5	31.6	
Level of Service	B	B		C	C	B	C	B	B	B	C	
Approach Delay (s)		19.3			20.7			17.2			28.9	
Approach LOS		B			C			B			C	

### Intersection Summary







HCM 2000 Control Delay	22.4	HCM 2000 Level of Service	C
HCM 2000 Volume to Capacity ratio	0.57		
Actuated Cycle Length (s)	65.0	Sum of lost time (s)	18.0
Intersection Capacity Utilization	52.4%	ICU Level of Service	A
Analysis Period (min)	15		

c Critical Lane Group

# HCM Signalized Intersection Capacity Analysis

## 6: Wade Road & Valencia Road

8/17/2015

							
Movement	EBU	EBT	EBR	WBL	WBT	NBL	NBR
Lane Configurations	↰	↕	↱	↰	↕	↱	↱
Traffic Volume (vph)	1	260	29	126	543	19	81
Future Volume (vph)	1	260	29	126	543	19	81
Ideal Flow (vphpl)	1900	1900	1900	1900	1900	1900	1900
Total Lost time (s)	4.5	4.5	4.5	4.5	4.5	4.5	4.5
Lane Util. Factor	1.00	0.95	1.00	1.00	0.95	1.00	1.00
Frt	1.00	1.00	0.85	1.00	1.00	1.00	0.85
Flt Protected	0.95	1.00	1.00	0.95	1.00	0.95	1.00
Satd. Flow (prot)	1770	3539	1583	1770	3539	1770	1583
Flt Permitted	0.43	1.00	1.00	0.55	1.00	0.95	1.00
Satd. Flow (perm)	794	3539	1583	1017	3539	1770	1583
Peak-hour factor, PHF	0.76	0.76	0.76	0.91	0.91	0.87	0.87
Adj. Flow (vph)	1	342	38	138	597	22	93
RTOR Reduction (vph)	0	0	27	0	0	0	75
Lane Group Flow (vph)	1	342	11	138	597	22	18
Turn Type	Perm	NA	Perm	pm+pt	NA	Prot	Perm
Protected Phases		4		3	8	2	
Permitted Phases	4		4	8			2
Actuated Green, G (s)	9.7	9.7	9.7	17.0	17.0	6.4	6.4
Effective Green, g (s)	9.7	9.7	9.7	17.0	17.0	6.4	6.4
Actuated g/C Ratio	0.30	0.30	0.30	0.52	0.52	0.20	0.20
Clearance Time (s)	4.5	4.5	4.5	4.5	4.5	4.5	4.5
Vehicle Extension (s)	3.0	3.0	3.0	3.0	3.0	3.0	3.0
Lane Grp Cap (vph)	237	1059	473	598	1856	349	312
v/s Ratio Prot		0.10		0.02	c0.17	c0.01	
v/s Ratio Perm	0.00		0.01	0.10			0.01
v/c Ratio	0.00	0.32	0.02	0.23	0.32	0.06	0.06
Uniform Delay, d1	8.0	8.8	8.0	4.2	4.4	10.6	10.6
Progression Factor	1.00	1.00	1.00	1.00	1.00	1.00	1.00
Incremental Delay, d2	0.0	0.2	0.0	0.2	0.1	0.1	0.1
Delay (s)	8.0	9.0	8.0	4.4	4.5	10.6	10.6
Level of Service	A	A	A	A	A	B	B
Approach Delay (s)		8.9			4.5	10.6	
Approach LOS		A			A	B	

### Intersection Summary

HCM 2000 Control Delay	6.4	HCM 2000 Level of Service	A
HCM 2000 Volume to Capacity ratio	0.31		
Actuated Cycle Length (s)	32.4	Sum of lost time (s)	13.5
Intersection Capacity Utilization	34.6%	ICU Level of Service	A
Analysis Period (min)	15		

c Critical Lane Group

HCM Signalized Intersection Capacity Analysis  
 3: Camino Verde & Valencia Road

8/17/2015

Movement	EBL	EBT	EBR	WBL	WBT	WBR	NBL	NBT	NBR	SBL	SBT	SBR
Lane Configurations												
Traffic Volume (vph)	326	588	0	37	206	30	4	172	194	112	17	109
Future Volume (vph)	326	588	0	37	206	30	4	172	194	112	17	109
Ideal Flow (vphpl)	1900	1900	1900	1900	1900	1900	1900	1900	1900	1900	1900	1900
Total Lost time (s)	4.5	4.5		4.5	4.5	4.5	4.5	4.5	4.5	4.5	4.5	
Lane Util. Factor	1.00	0.95		1.00	0.95	1.00	1.00	1.00	1.00	1.00	1.00	
Frt	1.00	1.00		1.00	1.00	0.85	1.00	1.00	0.85	1.00	0.87	
Flt Protected	0.95	1.00		0.95	1.00	1.00	0.95	1.00	1.00	0.95	1.00	
Satd. Flow (prot)	1770	3539		1770	3539	1583	1770	1863	1583	1770	1620	
Flt Permitted	0.61	1.00		0.27	1.00	1.00	0.67	1.00	1.00	0.61	1.00	
Satd. Flow (perm)	1140	3539		500	3539	1583	1248	1863	1583	1134	1620	
Peak-hour factor, PHF	0.92	0.92	0.92	0.92	0.92	0.92	0.92	0.92	0.92	0.92	0.92	0.92
Adj. Flow (vph)	354	639	0	40	224	33	4	187	211	122	18	118
RTOR Reduction (vph)	0	0	0	0	0	24	0	0	151	0	84	0
Lane Group Flow (vph)	354	639	0	40	224	9	4	187	60	122	52	0
Turn Type	pm+pt	NA		pm+pt	NA	Perm	pm+pt	NA	Perm	pm+pt	NA	
Protected Phases	7	4		3	8		5	2		1	6	
Permitted Phases	4			8		8	2		2	6		
Actuated Green, G (s)	24.0	18.5		23.0	18.0	18.0	23.5	18.5	18.5	23.5	18.5	
Effective Green, g (s)	24.0	18.5		23.0	18.0	18.0	23.5	18.5	18.5	23.5	18.5	
Actuated g/C Ratio	0.37	0.28		0.35	0.28	0.28	0.36	0.28	0.28	0.36	0.28	
Clearance Time (s)	4.5	4.5		4.5	4.5	4.5	4.5	4.5	4.5	4.5	4.5	
Lane Grp Cap (vph)	474	1007		274	980	438	491	530	450	458	461	
v/s Ratio Prot	c0.06	0.18		0.01	0.06		0.00	c0.10		c0.02	0.03	
v/s Ratio Perm	c0.21			0.04		0.01	0.00		0.04	0.08		
v/c Ratio	0.75	0.63		0.15	0.23	0.02	0.01	0.35	0.13	0.27	0.11	
Uniform Delay, d1	18.8	20.3		18.8	18.1	17.1	13.3	18.5	17.3	15.4	17.2	
Progression Factor	1.00	1.00		1.00	1.00	1.00	1.00	1.00	1.00	1.00	1.00	
Incremental Delay, d2	10.3	3.0		1.1	0.5	0.1	0.0	1.8	0.6	1.4	0.5	
Delay (s)	29.0	23.3		20.0	18.7	17.2	13.3	20.3	17.9	16.8	17.7	
Level of Service	C	C		B	B	B	B	C	B	B	B	
Approach Delay (s)		25.4			18.7			19.0			17.3	
Approach LOS		C			B			B			B	

Intersection Summary

HCM 2000 Control Delay	22.0	HCM 2000 Level of Service	C
HCM 2000 Volume to Capacity ratio	0.55		
Actuated Cycle Length (s)	65.0	Sum of lost time (s)	18.0
Intersection Capacity Utilization	54.0%	ICU Level of Service	A
Analysis Period (min)	15		

c Critical Lane Group



# HCM Signalized Intersection Capacity Analysis

## 6: Wade Road & Valencia Road

8/17/2015

Movement	EBU	EBT	EBR	WBL	WBT	NBL	NBR
Lane Configurations	↔	↔↔	↗	↖	↔↔	↖	↗
Traffic Volume (vph)	1	599	77	124	164	31	348
Future Volume (vph)	1	599	77	124	164	31	348
Ideal Flow (vphpl)	1900	1900	1900	1900	1900	1900	1900
Total Lost time (s)	4.5	4.5	4.5	4.5	4.5	4.5	4.5
Lane Util. Factor	1.00	0.95	1.00	1.00	0.95	1.00	1.00
Frt	1.00	1.00	0.85	1.00	1.00	1.00	0.85
Flt Protected	0.95	1.00	1.00	0.95	1.00	0.95	1.00
Satd. Flow (prot)	1770	3539	1583	1770	3539	1770	1583
Flt Permitted	0.62	1.00	1.00	0.37	1.00	0.95	1.00
Satd. Flow (perm)	1161	3539	1583	698	3539	1770	1583
Peak-hour factor, PHF	0.94	0.94	0.94	0.80	0.80	0.91	0.91
Adj. Flow (vph)	1	637	82	155	205	34	382
RTOR Reduction (vph)	0	0	54	0	0	0	247
Lane Group Flow (vph)	1	637	28	155	205	34	135
Turn Type	Perm	NA	Perm	pm+pt	NA	Prot	Perm
Protected Phases		4		3	8	2	
Permitted Phases	4		4	8			2
Actuated Green, G (s)	13.4	13.4	13.4	21.9	21.9	8.9	8.9
Effective Green, g (s)	13.4	13.4	13.4	21.9	21.9	8.9	8.9
Actuated g/C Ratio	0.34	0.34	0.34	0.55	0.55	0.22	0.22
Clearance Time (s)	4.5	4.5	4.5	4.5	4.5	4.5	4.5
Vehicle Extension (s)	3.0	3.0	3.0	3.0	3.0	3.0	3.0
Lane Grp Cap (vph)	390	1191	532	491	1947	395	353
v/s Ratio Prot		c0.18		c0.03	0.06	0.02	
v/s Ratio Perm	0.00		0.02	0.14			c0.09
v/c Ratio	0.00	0.53	0.05	0.32	0.11	0.09	0.38
Uniform Delay, d1	8.8	10.7	8.9	6.0	4.3	12.2	13.1
Progression Factor	1.00	1.00	1.00	1.00	1.00	1.00	1.00
Incremental Delay, d2	0.0	0.5	0.0	0.4	0.0	0.1	0.7
Delay (s)	8.8	11.1	9.0	6.3	4.3	12.3	13.8
Level of Service	A	B	A	A	A	B	B
Approach Delay (s)		10.9			5.2	13.7	
Approach LOS		B			A	B	

### Intersection Summary

HCM 2000 Control Delay	10.3	HCM 2000 Level of Service	B
HCM 2000 Volume to Capacity ratio	0.46		
Actuated Cycle Length (s)	39.8	Sum of lost time (s)	13.5
Intersection Capacity Utilization	45.6%	ICU Level of Service	A
Analysis Period (min)	15		
c Critical Lane Group			

# HCM Signalized Intersection Capacity Analysis

## 3: Camino Verde & Valencia Road

8/17/2015

Movement	EBL	EBT	EBR	WBL	WBT	WBR	NBL	NBT	NBR	SBL	SBT	SBR
Lane Configurations												
Traffic Volume (vph)	99	258	2	210	455	130	3	58	108	80	190	243
Future Volume (vph)	99	258	2	210	455	130	3	58	108	80	190	243
Ideal Flow (vphpl)	1900	1900	1900	1900	1900	1900	1900	1900	1900	1900	1900	1900
Total Lost time (s)	4.5	4.5		4.5	4.5	4.5	4.5	4.5	4.5	4.5	4.5	
Lane Util. Factor	1.00	0.95		1.00	0.95	1.00	1.00	1.00	1.00	1.00	1.00	
Fr't	1.00	1.00		1.00	1.00	0.85	1.00	1.00	0.85	1.00	0.92	
Flt Protected	0.95	1.00		0.95	1.00	1.00	0.95	1.00	1.00	0.95	1.00	
Satd. Flow (prot)	1770	3536		1770	3539	1583	1770	1863	1583	1770	1706	
Flt Permitted	0.38	1.00		0.57	1.00	1.00	0.21	1.00	1.00	0.72	1.00	
Satd. Flow (perm)	702	3536		1065	3539	1583	394	1863	1583	1334	1706	
Peak-hour factor, PHF	0.88	0.88	0.88	0.91	0.91	0.91	0.92	0.92	0.92	0.91	0.91	0.91
Adj. Flow (vph)	112	293	2	231	500	143	3	63	117	88	209	267
RTOR Reduction (vph)	0	1	0	0	0	103	0	0	83	0	71	0
Lane Group Flow (vph)	113	294	0	231	500	40	3	63	34	88	405	0
Turn Type	pm+pt	NA		pm+pt	NA	Perm	pm+pt	NA	Perm	pm+pt	NA	
Protected Phases	7	4		3	8		5	2		1	6	
Permitted Phases	4			8		8	2		2	6		
Actuated Green, G (s)	23.2	18.1		23.0	18.0	18.0	23.9	18.9	18.9	23.9	18.9	
Effective Green, g (s)	23.2	18.1		23.0	18.0	18.0	23.9	18.9	18.9	23.9	18.9	
Actuated g/C Ratio	0.36	0.28		0.35	0.28	0.28	0.37	0.29	0.29	0.37	0.29	
Clearance Time (s)	4.5	4.5		4.5	4.5	4.5	4.5	4.5	4.5	4.5	4.5	
Lane Grp Cap (vph)	334	984		431	980	438	250	541	460	524	496	
v/s Ratio Prot	0.03	0.08		c0.04	0.14		0.00	0.03		c0.01	c0.24	
v/s Ratio Perm	0.09			c0.15		0.03	0.00		0.02	0.05		
v/c Ratio	0.34	0.30		0.54	0.51	0.09	0.01	0.12	0.07	0.17	0.82	
Uniform Delay, d1	18.2	18.5		17.3	19.8	17.4	21.8	16.9	16.7	13.9	21.4	
Progression Factor	1.00	1.00		1.00	1.00	1.00	1.00	1.00	1.00	1.00	1.00	
Incremental Delay, d2	2.7	0.8		4.7	1.9	0.4	0.1	0.4	0.3	0.7	13.8	
Delay (s)	20.9	19.2		22.0	21.7	17.8	21.9	17.4	17.0	14.6	35.3	
Level of Service	C	B		C	C	B	C	B	B	B	D	
Approach Delay (s)		19.7			21.2			17.2			32.1	
Approach LOS		B			C			B			C	







### Intersection Summary

HCM 2000 Control Delay	23.5	HCM 2000 Level of Service	C
HCM 2000 Volume to Capacity ratio	0.61		
Actuated Cycle Length (s)	65.0	Sum of lost time (s)	18.0
Intersection Capacity Utilization	55.0%	ICU Level of Service	A
Analysis Period (min)	15		

c Critical Lane Group

HCM Signalized Intersection Capacity Analysis  
 6: Wade Road & Valencia Road

8/17/2015

							
Movement	EBU	EBT	EBR	WBL	WBT	NBL	NBR
Lane Configurations	↔	↕↕	↗	↖	↕↕	↖	↗
Traffic Volume (vph)	1	276	31	134	576	29	86
Future Volume (vph)	1	276	31	134	576	29	86
Ideal Flow (vphpl)	1900	1900	1900	1900	1900	1900	1900
Total Lost time (s)	4.5	4.5	4.5	4.5	4.5	4.5	4.5
Lane Util. Factor	1.00	0.95	1.00	1.00	0.95	1.00	1.00
Fr <sub>t</sub>	1.00	1.00	0.85	1.00	1.00	1.00	0.85
Fl <sub>t</sub> Protected	0.95	1.00	1.00	0.95	1.00	0.95	1.00
Satd. Flow (prot)	1770	3539	1583	1770	3539	1770	1583
Fl <sub>t</sub> Permitted	0.42	1.00	1.00	0.54	1.00	0.95	1.00
Satd. Flow (perm)	784	3539	1583	997	3539	1770	1583
Peak-hour factor, PHF	0.76	0.76	0.76	0.91	0.91	0.87	0.87
Adj. Flow (vph)	1	363	41	147	633	33	99
RTOR Reduction (vph)	0	0	29	0	0	0	80
Lane Group Flow (vph)	1	363	12	147	633	33	19
Turn Type	Perm	NA	Perm	pm+pt	NA	Prot	Perm
Protected Phases		4		3	8	2	
Permitted Phases	4		4	8			2
Actuated Green, G (s)	9.5	9.5	9.5	18.1	18.1	6.5	6.5
Effective Green, g (s)	9.5	9.5	9.5	18.1	18.1	6.5	6.5
Actuated g/C Ratio	0.28	0.28	0.28	0.54	0.54	0.19	0.19
Clearance Time (s)	4.5	4.5	4.5	4.5	4.5	4.5	4.5
Vehicle Extension (s)	3.0	3.0	3.0	3.0	3.0	3.0	3.0
Lane Grp Cap (vph)	221	1000	447	631	1906	342	306
v/s Ratio Prot		0.10		0.03	c0.18	c0.02	
v/s Ratio Perm	0.00		0.01	0.10			0.01
v/c Ratio	0.00	0.36	0.03	0.23	0.33	0.10	0.06
Uniform Delay, d <sub>1</sub>	8.7	9.6	8.7	4.2	4.4	11.1	11.1
Progression Factor	1.00	1.00	1.00	1.00	1.00	1.00	1.00
Incremental Delay, d <sub>2</sub>	0.0	0.2	0.0	0.2	0.1	0.1	0.1
Delay (s)	8.7	9.9	8.7	4.4	4.5	11.3	11.1
Level of Service	A	A	A	A	A	B	B
Approach Delay (s)		9.7			4.4	11.2	
Approach LOS		A			A	B	

Intersection Summary			
HCM 2000 Control Delay	6.7	HCM 2000 Level of Service	A
HCM 2000 Volume to Capacity ratio	0.33		
Actuated Cycle Length (s)	33.6	Sum of lost time (s)	13.5
Intersection Capacity Utilization	35.5%	ICU Level of Service	A
Analysis Period (min)	15		
c Critical Lane Group			

# HCM Signalized Intersection Capacity Analysis

## 3: Camino Verde & Valencia Road

8/17/2015

Movement	EBL	EBT	EBR	WBL	WBT	WBR	NBL	NBT	NBR	SBL	SBT	SBR
Lane Configurations												
Traffic Volume (vph)	333	602	5	37	229	30	12	172	194	112	17	121
Future Volume (vph)	333	602	5	37	229	30	12	172	194	112	17	121
Ideal Flow (vphpl)	1900	1900	1900	1900	1900	1900	1900	1900	1900	1900	1900	1900
Total Lost time (s)	4.5	4.5		4.5	4.5	4.5	4.5	4.5	4.5	4.5	4.5	
Lane Util. Factor	1.00	0.95		1.00	0.95	1.00	1.00	1.00	1.00	1.00	1.00	
Frt	1.00	1.00		1.00	1.00	0.85	1.00	1.00	0.85	1.00	0.87	
Flt Protected	0.95	1.00		0.95	1.00	1.00	0.95	1.00	1.00	0.95	1.00	
Satd. Flow (prot)	1770	3535		1770	3539	1583	1770	1863	1583	1770	1617	
Flt Permitted	0.60	1.00		0.25	1.00	1.00	0.66	1.00	1.00	0.61	1.00	
Satd. Flow (perm)	1113	3535		473	3539	1583	1232	1863	1583	1134	1617	
Peak-hour factor, PHF	0.92	0.92	0.92	0.92	0.92	0.92	0.92	0.92	0.92	0.92	0.92	0.92
Adj. Flow (vph)	362	654	5	40	249	33	13	187	211	122	18	132
RTOR Reduction (vph)	0	1	0	0	0	24	0	0	151	0	94	0
Lane Group Flow (vph)	362	658	0	40	249	9	13	187	60	122	56	0
Turn Type	pm+pt	NA		pm+pt	NA	Perm	pm+pt	NA	Perm	pm+pt	NA	
Protected Phases	7	4		3	8		5	2		1	6	
Permitted Phases	4			8		8	2		2	6		
Actuated Green, G (s)	24.0	18.5		23.0	18.0	18.0	23.5	18.5	18.5	23.5	18.5	
Effective Green, g (s)	24.0	18.5		23.0	18.0	18.0	23.5	18.5	18.5	23.5	18.5	
Actuated g/C Ratio	0.37	0.28		0.35	0.28	0.28	0.36	0.28	0.28	0.36	0.28	
Clearance Time (s)	4.5	4.5		4.5	4.5	4.5	4.5	4.5	4.5	4.5	4.5	
Lane Grp Cap (vph)	466	1006		267	980	438	486	530	450	458	460	
v/s Ratio Prot	c0.07	0.19		0.01	0.07		0.00	c0.10		c0.02	0.03	
v/s Ratio Perm	c0.22			0.04		0.01	0.01		0.04	0.08		
v/c Ratio	0.78	0.65		0.15	0.25	0.02	0.03	0.35	0.13	0.27	0.12	
Uniform Delay, d1	18.9	20.4		19.2	18.3	17.1	13.4	18.5	17.3	15.4	17.2	
Progression Factor	1.00	1.00		1.00	1.00	1.00	1.00	1.00	1.00	1.00	1.00	
Incremental Delay, d2	12.0	3.3		1.2	0.6	0.1	0.1	1.8	0.6	1.4	0.5	
Delay (s)	30.9	23.8		20.4	18.9	17.2	13.5	20.3	17.9	16.8	17.8	
Level of Service	C	C		C	B	B	B	C	B	B	B	
Approach Delay (s)		26.3			18.9			18.9			17.3	
Approach LOS		C			B			B			B	

### Intersection Summary

HCM 2000 Control Delay	22.4	HCM 2000 Level of Service	C
HCM 2000 Volume to Capacity ratio	0.56		
Actuated Cycle Length (s)	65.0	Sum of lost time (s)	18.0
Intersection Capacity Utilization	55.0%	ICU Level of Service	B
Analysis Period (min)	15		

c Critical Lane Group

# HCM Signalized Intersection Capacity Analysis

## 6: Wade Road & Valencia Road

8/17/2015

Movement	EBL	EBT	EBR	WBL	WBT	WBR	NBL	NBT	NBR	SBL	SBT	SBR
Lane Configurations												
Traffic Volume (vph)	23	608	77	124	186	22	37	6	348	17	7	1
Future Volume (vph)	23	608	77	124	186	22	37	6	348	17	7	1
Ideal Flow (vphpl)	1900	1900	1900	1900	1900	1900	1900	1900	1900	1900	1900	1900
Total Lost time (s)	4.5	4.5	4.5	4.5	4.5		4.5	4.5		4.5	4.5	
Lane Util. Factor	1.00	0.95	1.00	1.00	0.95		1.00	1.00		1.00	1.00	
Frt	1.00	1.00	0.85	1.00	0.99		1.00	0.85		1.00	0.98	
Flt Protected	0.95	1.00	1.00	0.95	1.00		0.95	1.00		0.95	1.00	
Satd. Flow (prot)	1770	3539	1583	1770	3490		1770	1588		1770	1832	
Flt Permitted	0.59	1.00	1.00	0.32	1.00		0.95	1.00		0.58	1.00	
Satd. Flow (perm)	1104	3539	1583	594	3490		1770	1588		1080	1832	
Peak-hour factor, PHF	0.92	0.94	0.94	0.80	0.80	0.92	0.91	0.92	0.91	0.92	0.92	0.92
Adj. Flow (vph)	25	647	82	155	232	24	41	7	382	18	8	1
RTOR Reduction (vph)	0	0	58	0	9	0	0	320	0	0	1	0
Lane Group Flow (vph)	25	647	24	155	248	0	41	69	0	18	8	0
Turn Type	Perm	NA	Perm	pm+pt	NA		Split	NA		Perm	NA	
Protected Phases		4		3	8		2	2			6	
Permitted Phases	4		4	8						6		
Actuated Green, G (s)	15.5	15.5	15.5	24.1	24.1		8.7	8.7		6.9	6.9	
Effective Green, g (s)	15.5	15.5	15.5	24.1	24.1		8.7	8.7		6.9	6.9	
Actuated g/C Ratio	0.29	0.29	0.29	0.45	0.45		0.16	0.16		0.13	0.13	
Clearance Time (s)	4.5	4.5	4.5	4.5	4.5		4.5	4.5		4.5	4.5	
Vehicle Extension (s)	3.0	3.0	3.0	3.0	3.0		3.0	3.0		3.0	3.0	
Lane Grp Cap (vph)	321	1031	461	359	1580		289	259		140	237	
v/s Ratio Prot		c0.18		c0.03	0.07		0.02	c0.04			0.00	
v/s Ratio Perm	0.02		0.02	0.16						c0.02		
v/c Ratio	0.08	0.63	0.05	0.43	0.16		0.14	0.27		0.13	0.03	
Uniform Delay, d1	13.7	16.3	13.6	13.2	8.6		19.1	19.5		20.5	20.2	
Progression Factor	1.00	1.00	1.00	1.00	1.00		1.00	1.00		1.00	1.00	
Incremental Delay, d2	0.1	1.2	0.0	0.8	0.0		0.2	0.6		0.4	0.1	
Delay (s)	13.8	17.6	13.6	14.0	8.6		19.3	20.0		20.9	20.3	
Level of Service	B	B	B	B	A		B	C		C	C	
Approach Delay (s)		17.0			10.6			20.0			20.7	
Approach LOS		B			B			B			C	

### Intersection Summary







HCM 2000 Control Delay	16.2	HCM 2000 Level of Service	B
HCM 2000 Volume to Capacity ratio	0.43		
Actuated Cycle Length (s)	53.2	Sum of lost time (s)	18.0
Intersection Capacity Utilization	56.8%	ICU Level of Service	B
Analysis Period (min)	15		

c Critical Lane Group

# HCM Unsignalized Intersection Capacity Analysis









## 8: Valencia Road & Val Dwy 3

8/17/2015

						
Movement	EBL	EBT	WBT	WBR	SBL	SBR
Lane Configurations		↑↑	↑↑			↑
Traffic Volume (veh/h)	0	708	214	9	0	8
Future Volume (Veh/h)	0	708	214	9	0	8
Sign Control		Free	Free		Stop	
Grade		0%	0%		0%	
Peak Hour Factor	0.92	0.92	0.92	0.92	0.92	0.92
Hourly flow rate (vph)	0	770	233	10	0	9
Pedestrians						
Lane Width (ft)						
Walking Speed (ft/s)						
Percent Blockage						
Right turn flare (veh)						
Median type		None	None			
Median storage (veh)						
Upstream signal (ft)			360			
pX, platoon unblocked						
vC, conflicting volume	243				623	122
vC1, stage 1 conf vol						
vC2, stage 2 conf vol						
vCu, unblocked vol	243				623	122
tC, single (s)	4.1				6.8	6.9
tC, 2 stage (s)						
tF (s)	2.2				3.5	3.3
p0 queue free %	100				100	99
cM capacity (veh/h)	1320				418	907
Direction, Lane #	EB 1	EB 2	WB 1	WB 2	SB 1	
Volume Total	385	385	155	88	9	
Volume Left	0	0	0	0	0	
Volume Right	0	0	0	10	9	
cSH	1700	1700	1700	1700	907	
Volume to Capacity	0.23	0.23	0.09	0.05	0.01	
Queue Length 95th (ft)	0	0	0	0	1	
Control Delay (s)	0.0	0.0	0.0	0.0	9.0	
Lane LOS					A	
Approach Delay (s)	0.0		0.0		9.0	
Approach LOS					A	
Intersection Summary						
Average Delay			0.1			
Intersection Capacity Utilization			22.9%		ICU Level of Service	A
Analysis Period (min)			15			







HCM Unsignalized Intersection Capacity Analysis  
 10: Valencia Road & Val Dwy 2

8/17/2015

						
Movement	EBL	EBT	WBT	WBR	SBL	SBR
Lane Configurations						
Traffic Volume (veh/h)	0	708	213	9	0	8
Future Volume (Veh/h)	0	708	213	9	0	8
Sign Control		Free	Free		Stop	
Grade		0%	0%		0%	
Peak Hour Factor	0.92	0.92	0.92	0.92	0.92	0.92
Hourly flow rate (vph)	0	770	232	10	0	9
Pedestrians						
Lane Width (ft)						
Walking Speed (ft/s)						
Percent Blockage						
Right turn flare (veh)						
Median type		None	None			
Median storage (veh)						
Upstream signal (ft)			700			
pX, platoon unblocked						
vC, conflicting volume	242				622	121
vC1, stage 1 conf vol						
vC2, stage 2 conf vol						
vCu, unblocked vol	242				622	121
tC, single (s)	4.1				6.8	6.9
tC, 2 stage (s)						
tF (s)	2.2				3.5	3.3
p0 queue free %	100				100	99
cM capacity (veh/h)	1322				419	908
Direction, Lane #	EB 1	EB 2	WB 1	WB 2	SB 1	
Volume Total	385	385	155	87	9	
Volume Left	0	0	0	0	0	
Volume Right	0	0	0	10	9	
cSH	1700	1700	1700	1700	908	
Volume to Capacity	0.23	0.23	0.09	0.05	0.01	
Queue Length 95th (ft)	0	0	0	0	1	
Control Delay (s)	0.0	0.0	0.0	0.0	9.0	
Lane LOS					A	
Approach Delay (s)	0.0		0.0		9.0	
Approach LOS					A	
Intersection Summary						
Average Delay			0.1			
Intersection Capacity Utilization			22.9%		ICU Level of Service	A
Analysis Period (min)			15			

HCM Unsignalized Intersection Capacity Analysis  
 12: Valencia Road & Val Dwy 1









8/17/2015

						
Movement	EBL	EBT	WBT	WBR	SBL	SBR
Lane Configurations		↑↑	↑↑			↑
Traffic Volume (veh/h)	0	708	212	9	0	7
Future Volume (Veh/h)	0	708	212	9	0	7
Sign Control		Free	Free		Stop	
Grade		0%	0%		0%	
Peak Hour Factor	0.92	0.92	0.92	0.92	0.92	0.92
Hourly flow rate (vph)	0	770	230	10	0	8
Pedestrians						
Lane Width (ft)						
Walking Speed (ft/s)						
Percent Blockage						
Right turn flare (veh)						
Median type		None	None			
Median storage veh						
Upstream signal (ft)			1070			
pX, platoon unblocked						
vC, conflicting volume	240				620	120
vC1, stage 1 conf vol						
vC2, stage 2 conf vol						
vCu, unblocked vol	240				620	120
tC, single (s)	4.1				6.8	6.9
tC, 2 stage (s)						
tF (s)	2.2				3.5	3.3
p0 queue free %	100				100	99
cM capacity (veh/h)	1324				420	909
Direction, Lane #	EB 1	EB 2	WB 1	WB 2	SB 1	
Volume Total	385	385	153	87	8	
Volume Left	0	0	0	0	0	
Volume Right	0	0	0	10	8	
cSH	1700	1700	1700	1700	909	
Volume to Capacity	0.23	0.23	0.09	0.05	0.01	
Queue Length 95th (ft)	0	0	0	0	1	
Control Delay (s)	0.0	0.0	0.0	0.0	9.0	
Lane LOS					A	
Approach Delay (s)	0.0		0.0		9.0	
Approach LOS					A	
<b>Intersection Summary</b>						
Average Delay			0.1			
Intersection Capacity Utilization			22.9%		ICU Level of Service	A
Analysis Period (min)			15			











HCM Unsignalized Intersection Capacity Analysis  
 15: Wade Road & Wade Dwy 3

8/17/2015

						
Movement	EBL	EBR	NBL	NBT	SBT	SBR
Lane Configurations						
Traffic Volume (veh/h)	0	7	17	0	0	0
Future Volume (Veh/h)	0	7	17	0	0	0
Sign Control	Stop			Free	Free	
Grade	0%			0%	0%	
Peak Hour Factor	0.92	0.92	0.92	0.92	0.92	0.92
Hourly flow rate (vph)	0	8	18	0	0	0
Pedestrians						
Lane Width (ft)						
Walking Speed (ft/s)						
Percent Blockage						
Right turn flare (veh)						
Median type				None	None	
Median storage (veh)						
Upstream signal (ft)				751		
pX, platoon unblocked						
vC, conflicting volume	36	0	0			
vC1, stage 1 conf vol						
vC2, stage 2 conf vol						
vCu, unblocked vol	36	0	0			
tC, single (s)	6.4	6.2	4.1			
tC, 2 stage (s)						
tF (s)	3.5	3.3	2.2			
p0 queue free %	100	99	99			
cM capacity (veh/h)	966	1085	1623			
Direction, Lane #	EB 1	NB 1	SB 1			
Volume Total	8	18	0			
Volume Left	0	18	0			
Volume Right	8	0	0			
cSH	1085	1623	1700			
Volume to Capacity	0.01	0.01	0.00			
Queue Length 95th (ft)	1	1	0			
Control Delay (s)	8.3	7.2	0.0			
Lane LOS	A	A				
Approach Delay (s)	8.3	7.2	0.0			
Approach LOS	A					
<b>Intersection Summary</b>						
Average Delay			7.6			
Intersection Capacity Utilization			13.3%	ICU Level of Service		A
Analysis Period (min)			15			









HCM Unsignalized Intersection Capacity Analysis  
 17: Wade Road & Wade Dwy 2

8/17/2015

						
Movement	EBL	EBR	NBL	NBT	SBT	SBR
Lane Configurations						
Traffic Volume (veh/h)	0	8	17	17	7	0
Future Volume (Veh/h)	0	8	17	17	7	0
Sign Control	Stop			Free	Free	
Grade	0%			0%	0%	
Peak Hour Factor	0.92	0.92	0.92	0.92	0.92	0.92
Hourly flow rate (vph)	0	9	18	18	8	0
Pedestrians						
Lane Width (ft)						
Walking Speed (ft/s)						
Percent Blockage						
Right turn flare (veh)						
Median type				None	None	
Median storage (veh)						
Upstream signal (ft)				491		
pX, platoon unblocked						
vC, conflicting volume	62	8	8			
vC1, stage 1 conf vol						
vC2, stage 2 conf vol						
vCu, unblocked vol	62	8	8			
tC, single (s)	6.4	6.2	4.1			
tC, 2 stage (s)						
tF (s)	3.5	3.3	2.2			
p0 queue free %	100	99	99			
cM capacity (veh/h)	934	1074	1612			
<b>Direction, Lane #</b>	<b>EB 1</b>	<b>NB 1</b>	<b>SB 1</b>			
Volume Total	9	36	8			
Volume Left	0	18	0			
Volume Right	9	0	0			
cSH	1074	1612	1700			
Volume to Capacity	0.01	0.01	0.00			
Queue Length 95th (ft)	1	1	0			
Control Delay (s)	8.4	3.7	0.0			
Lane LOS	A	A				
Approach Delay (s)	8.4	3.7	0.0			
Approach LOS	A					
<b>Intersection Summary</b>						
Average Delay			3.9			
Intersection Capacity Utilization			18.5%	ICU Level of Service		A
Analysis Period (min)			15			

HCM Unsignalized Intersection Capacity Analysis  
 19: Wade Road & Wade Dwy 1

8/17/2015

						
Movement	EBL	EBR	NBL	NBT	SBT	SBR
Lane Configurations						
Traffic Volume (veh/h)	0	9	17	34	15	0
Future Volume (Veh/h)	0	9	17	34	15	0
Sign Control	Stop			Free	Free	
Grade	0%			0%	0%	
Peak Hour Factor	0.92	0.92	0.92	0.92	0.92	0.92
Hourly flow rate (vph)	0	10	18	37	16	0
Pedestrians						
Lane Width (ft)						
Walking Speed (ft/s)						
Percent Blockage						
Right turn flare (veh)						
Median type				None	None	
Median storage (veh)						
Upstream signal (ft)				361		
pX, platoon unblocked						
vC, conflicting volume	89	16	16			
vC1, stage 1 conf vol						
vC2, stage 2 conf vol						
vCu, unblocked vol	89	16	16			
tC, single (s)	6.4	6.2	4.1			
tC, 2 stage (s)						
tF (s)	3.5	3.3	2.2			
p0 queue free %	100	99	99			
cM capacity (veh/h)	901	1063	1602			
<b>Direction, Lane #</b>	<b>EB 1</b>	<b>NB 1</b>	<b>SB 1</b>			
Volume Total	10	55	16			
Volume Left	0	18	0			
Volume Right	10	0	0			
cSH	1063	1602	1700			
Volume to Capacity	0.01	0.01	0.01			
Queue Length 95th (ft)	1	1	0			
Control Delay (s)	8.4	2.4	0.0			
Lane LOS	A	A				
Approach Delay (s)	8.4	2.4	0.0			
Approach LOS	A					
<b>Intersection Summary</b>						
Average Delay			2.7			
Intersection Capacity Utilization			19.4%	ICU Level of Service		A
Analysis Period (min)			15			

HCM Unsignalized Intersection Capacity Analysis  
 21: Star Diamond Place & Valencia Road











8/17/2015

	→	↘	↙	↗	←	↖	↘
Movement	EBT	EBR	WBU	WBL	WBT	NBL	NBR
Lane Configurations	↑↑			↘	↑↑	↘	
Traffic Volume (veh/h)	694	10	9	10	200	5	5
Future Volume (Veh/h)	694	10	9	10	200	5	5
Sign Control	Free				Free	Stop	
Grade	0%				0%	0%	
Peak Hour Factor	0.92	0.92	0.92	0.92	0.92	0.92	0.92
Hourly flow rate (vph)	754	11	0	11	217	5	5
Pedestrians							
Lane Width (ft)							
Walking Speed (ft/s)							
Percent Blockage							
Right turn flare (veh)							
Median type	None				None		
Median storage (veh)							
Upstream signal (ft)							
pX, platoon unblocked			0.00				
vC, conflicting volume			0	765		890	382
vC1, stage 1 conf vol							
vC2, stage 2 conf vol							
vCu, unblocked vol			0	765		890	382
tC, single (s)			0.0	4.1		6.8	6.9
tC, 2 stage (s)							
tF (s)			0.0	2.2		3.5	3.3
p0 queue free %			0	99		98	99
cM capacity (veh/h)			0	844		279	616
Direction, Lane #	EB 1	EB 2	WB 1	WB 2	WB 3	NB 1	
Volume Total	503	262	11	108	108	10	
Volume Left	0	0	11	0	0	5	
Volume Right	0	11	0	0	0	5	
cSH	1700	1700	844	1700	1700	384	
Volume to Capacity	0.30	0.15	0.01	0.06	0.06	0.03	
Queue Length 95th (ft)	0	0	1	0	0	2	
Control Delay (s)	0.0	0.0	9.3	0.0	0.0	14.6	
Lane LOS			A			B	
Approach Delay (s)	0.0		0.4			14.6	
Approach LOS						B	
<b>Intersection Summary</b>							
Average Delay			0.2				
Intersection Capacity Utilization			29.5%		ICU Level of Service		A
Analysis Period (min)			15				

Queues

3: Camino Verde & Valencia Road

8/17/2015

										
Lane Group	EBL	EBT	WBL	WBT	WBR	NBL	NBT	NBR	SBL	SBT
Lane Group Flow (vph)	362	659	40	249	33	13	187	211	122	150
v/c Ratio	0.78	0.65	0.15	0.25	0.06	0.03	0.35	0.35	0.27	0.27
Control Delay	30.5	24.1	13.9	19.1	0.2	11.1	20.8	5.0	13.9	6.4
Queue Delay	0.0	0.0	0.0	0.0	0.0	0.0	0.0	0.0	0.0	0.0
Total Delay	30.5	24.1	13.9	19.1	0.2	11.1	20.8	5.0	13.9	6.4
Queue Length 50th (ft)	98	119	9	40	0	3	58	0	28	5
Queue Length 95th (ft)	#204	172	24	67	0	11	108	43	57	42
Internal Link Dist (ft)		2544		1040			1270			1115
Turn Bay Length (ft)	400		190		190	200		200	350	
Base Capacity (vph)	466	1007	267	980	565	487	530	601	458	554
Starvation Cap Reductn	0	0	0	0	0	0	0	0	0	0
Spillback Cap Reductn	0	0	0	0	0	0	0	0	0	0
Storage Cap Reductn	0	0	0	0	0	0	0	0	0	0
Reduced v/c Ratio	0.78	0.65	0.15	0.25	0.06	0.03	0.35	0.35	0.27	0.27









Intersection Summary

# 95th percentile volume exceeds capacity, queue may be longer.  
 Queue shown is maximum after two cycles.

Queues

6: Wade Road & Valencia Road

8/17/2015

									
Lane Group	EBL	EBT	EBR	WBL	WBT	NBL	NBT	SBL	SBT
Lane Group Flow (vph)	25	647	82	155	257	41	389	18	9
v/c Ratio	0.08	0.62	0.14	0.38	0.17	0.14	0.67	0.13	0.04
Control Delay	17.1	20.5	1.4	16.6	9.1	21.5	9.5	26.5	23.4
Queue Delay	0.0	0.0	0.0	0.0	0.0	0.0	0.0	0.0	0.0
Total Delay	17.1	20.5	1.4	16.6	9.1	21.5	9.5	26.5	23.4
Queue Length 50th (ft)	5	88	0	24	19	12	2	5	2
Queue Length 95th (ft)	25	179	7	65	46	35	63	24	15
Internal Link Dist (ft)		280			2544		1230		281
Turn Bay Length (ft)	200		150	500		400			
Base Capacity (vph)	395	1267	661	406	1951	633	814	386	656
Starvation Cap Reductn	0	0	0	0	0	0	0	0	0
Spillback Cap Reductn	0	0	0	0	0	0	0	0	0
Storage Cap Reductn	0	0	0	0	0	0	0	0	0
Reduced v/c Ratio	0.06	0.51	0.12	0.38	0.13	0.06	0.48	0.05	0.01
<b>Intersection Summary</b>									

# HCM Signalized Intersection Capacity Analysis

## 3: Camino Verde & Valencia Road

8/17/2015

Movement	EBL	EBT	EBR	WBL	WBT	WBR	NBL	NBT	NBR	SBL	SBT	SBR
Lane Configurations												
Traffic Volume (vph)	123	308	19	210	501	130	18	58	108	80	190	265
Future Volume (vph)	123	308	19	210	501	130	18	58	108	80	190	265
Ideal Flow (vphpl)	1900	1900	1900	1900	1900	1900	1900	1900	1900	1900	1900	1900
Total Lost time (s)	4.5	4.5		4.5	4.5	4.5	4.5	4.5	4.5	4.5	4.5	
Lane Util. Factor	1.00	0.95		1.00	0.95	1.00	1.00	1.00	1.00	1.00	1.00	
Fr <sub>t</sub>	1.00	0.99		1.00	1.00	0.85	1.00	1.00	0.85	1.00	0.91	
Fl <sub>t</sub> Protected	0.95	1.00		0.95	1.00	1.00	0.95	1.00	1.00	0.95	1.00	
Satd. Flow (prot)	1770	3508		1770	3539	1583	1770	1863	1583	1770	1700	
Fl <sub>t</sub> Permitted	0.34	1.00		0.51	1.00	1.00	0.22	1.00	1.00	0.72	1.00	
Satd. Flow (perm)	636	3508		953	3539	1583	403	1863	1583	1334	1700	
Peak-hour factor, PHF	0.92	0.92	0.92	0.92	0.92	0.92	0.92	0.92	0.92	0.92	0.92	0.92
Adj. Flow (vph)	134	335	21	228	545	141	20	63	117	87	207	288
RTOR Reduction (vph)	0	7	0	0	0	102	0	0	84	0	77	0
Lane Group Flow (vph)	134	349	0	228	545	39	20	63	33	87	418	0
Turn Type	pm+pt	NA		pm+pt	NA	Perm	pm+pt	NA	Perm	pm+pt	NA	
Protected Phases	7	4		3	8		5	2		1	6	
Permitted Phases	4			8		8	2		2	6		
Actuated Green, G (s)	24.0	18.5		23.0	18.0	18.0	23.5	18.5	18.5	23.5	18.5	
Effective Green, g (s)	24.0	18.5		23.0	18.0	18.0	23.5	18.5	18.5	23.5	18.5	
Actuated g/C Ratio	0.37	0.28		0.35	0.28	0.28	0.36	0.28	0.28	0.36	0.28	
Clearance Time (s)	4.5	4.5		4.5	4.5	4.5	4.5	4.5	4.5	4.5	4.5	
Lane Grp Cap (vph)	330	998		400	980	438	250	530	450	515	483	
v/s Ratio Prot	0.03	0.10		c0.04	0.15		0.01	0.03		c0.01	c0.25	
v/s Ratio Perm	0.12			c0.16		0.02	0.02		0.02	0.05		
v/c Ratio	0.41	0.35		0.57	0.56	0.09	0.08	0.12	0.07	0.17	0.86	
Uniform Delay, d1	18.9	18.5		18.3	20.1	17.4	23.3	17.2	17.0	14.2	22.1	
Progression Factor	1.00	1.00		1.00	1.00	1.00	1.00	1.00	1.00	1.00	1.00	
Incremental Delay, d2	3.7	1.0		5.8	2.3	0.4	0.6	0.5	0.3	0.7	18.3	
Delay (s)	22.6	19.4		24.1	22.4	17.8	23.9	17.7	17.3	14.9	40.4	
Level of Service	C	B		C	C	B	C	B	B	B	D	
Approach Delay (s)		20.3			22.1			18.1			36.6	
Approach LOS		C			C			B			D	

### Intersection Summary

HCM 2000 Control Delay	25.2	HCM 2000 Level of Service	C
HCM 2000 Volume to Capacity ratio	0.64		
Actuated Cycle Length (s)	65.0	Sum of lost time (s)	18.0
Intersection Capacity Utilization	58.2%	ICU Level of Service	B
Analysis Period (min)	15		

c Critical Lane Group

# HCM Signalized Intersection Capacity Analysis

## 6: Wade Road & Valencia Road

8/17/2015

Movement	EBL	EBT	EBR	WBL	WBT	WBR	NBL	NBT	NBR	SBL	SBT	SBR
Lane Configurations												
Traffic Volume (vph)	69	298	31	134	616	63	26	11	86	92	37	1
Future Volume (vph)	69	298	31	134	616	63	26	11	86	92	37	1
Ideal Flow (vphpl)	1900	1900	1900	1900	1900	1900	1900	1900	1900	1900	1900	1900
Total Lost time (s)	4.5	4.5	4.5	4.5	4.5		4.5	4.5		4.5	4.5	
Lane Util. Factor	1.00	0.95	1.00	1.00	0.95		1.00	1.00		1.00	1.00	
Fr <sub>t</sub>	1.00	1.00	0.85	1.00	0.99		1.00	0.87		1.00	1.00	
Fl <sub>t</sub> Protected	0.95	1.00	1.00	0.95	1.00		0.95	1.00		0.95	1.00	
Satd. Flow (prot)	1770	3539	1583	1770	3496		1770	1615		1770	1856	
Fl <sub>t</sub> Permitted	0.25	1.00	1.00	0.56	1.00		0.95	1.00		0.69	1.00	
Satd. Flow (perm)	457	3539	1583	1042	3496		1770	1615		1281	1856	
Peak-hour factor, PHF	0.92	0.94	0.94	0.80	0.80	0.92	0.91	0.92	0.91	0.92	0.92	0.92
Adj. Flow (vph)	75	317	33	168	770	68	29	12	95	100	40	1
RTOR Reduction (vph)	0	0	23	0	7	0	0	83	0	0	1	0
Lane Group Flow (vph)	75	317	10	168	831	0	29	24	0	100	40	0
Turn Type	Perm	NA	Perm	pm+pt	NA		Split	NA		Perm	NA	
Protected Phases		4		3	8		2	2			6	
Permitted Phases	4		4	8						6		
Actuated Green, G (s)	16.3	16.3	16.3	24.9	24.9		7.0	7.0		9.8	9.8	
Effective Green, g (s)	16.3	16.3	16.3	24.9	24.9		7.0	7.0		9.8	9.8	
Actuated g/C Ratio	0.30	0.30	0.30	0.45	0.45		0.13	0.13		0.18	0.18	
Clearance Time (s)	4.5	4.5	4.5	4.5	4.5		4.5	4.5		4.5	4.5	
Vehicle Extension (s)	3.0	3.0	3.0	3.0	3.0		3.0	3.0		3.0	3.0	
Lane Grp Cap (vph)	134	1045	467	524	1577		224	204		227	329	
v/s Ratio Prot		0.09		0.02	c0.24		c0.02	0.01			0.02	
v/s Ratio Perm	0.16		0.01	0.12						c0.08		
v/c Ratio	0.56	0.30	0.02	0.32	0.53		0.13	0.12		0.44	0.12	
Uniform Delay, d1	16.4	15.1	13.8	9.9	10.9		21.4	21.4		20.3	19.1	
Progression Factor	1.00	1.00	1.00	1.00	1.00		1.00	1.00		1.00	1.00	
Incremental Delay, d2	5.0	0.2	0.0	0.4	0.3		0.3	0.3		1.4	0.2	
Delay (s)	21.4	15.2	13.8	10.3	11.2		21.7	21.6		21.6	19.3	
Level of Service	C	B	B	B	B		C	C		C	B	
Approach Delay (s)		16.2			11.1			21.6			20.9	
Approach LOS		B			B			C			C	

### Intersection Summary

HCM 2000 Control Delay	14.0	HCM 2000 Level of Service	B
HCM 2000 Volume to Capacity ratio	0.49		
Actuated Cycle Length (s)	55.2	Sum of lost time (s)	18.0
Intersection Capacity Utilization	46.2%	ICU Level of Service	A
Analysis Period (min)	15		







c Critical Lane Group



# HCM Unsignalized Intersection Capacity Analysis







## 8: Valencia Road & Val Dwy 3

8/17/2015

						
Movement	EBL	EBT	WBT	WBR	SBL	SBR
Lane Configurations		↑↑	↑↑			↑
Traffic Volume (veh/h)	0	398	616	27	0	40
Future Volume (Veh/h)	0	398	616	27	0	40
Sign Control		Free	Free		Stop	
Grade		0%	0%		0%	
Peak Hour Factor	0.92	0.92	0.92	0.92	0.92	0.92
Hourly flow rate (vph)	0	433	670	29	0	43
Pedestrians						
Lane Width (ft)						
Walking Speed (ft/s)						
Percent Blockage						
Right turn flare (veh)						
Median type		None	None			
Median storage (veh)						
Upstream signal (ft)			360			
pX, platoon unblocked	0.86				0.86	0.86
vC, conflicting volume	699				901	350
vC1, stage 1 conf vol						
vC2, stage 2 conf vol						
vCu, unblocked vol	339				573	0
tC, single (s)	4.1				6.8	6.9
tC, 2 stage (s)						
tF (s)	2.2				3.5	3.3
p0 queue free %	100				100	95
cM capacity (veh/h)	1052				389	938
Direction, Lane #	EB 1	EB 2	WB 1	WB 2	SB 1	
Volume Total	216	216	447	252	43	
Volume Left	0	0	0	0	0	
Volume Right	0	0	0	29	43	
cSH	1700	1700	1700	1700	938	
Volume to Capacity	0.13	0.13	0.26	0.15	0.05	
Queue Length 95th (ft)	0	0	0	0	4	
Control Delay (s)	0.0	0.0	0.0	0.0	9.0	
Lane LOS					A	
Approach Delay (s)	0.0		0.0		9.0	
Approach LOS					A	
Intersection Summary						
Average Delay			0.3			
Intersection Capacity Utilization			27.9%		ICU Level of Service	A
Analysis Period (min)			15			







HCM Unsignalized Intersection Capacity Analysis  
 10: Valencia Road & Val Dwy 2

8/17/2015

						
Movement	EBL	EBT	WBT	WBR	SBL	SBR
Lane Configurations		↑↑	↑↑			↑
Traffic Volume (veh/h)	0	398	629	27	0	40
Future Volume (Veh/h)	0	398	629	27	0	40
Sign Control		Free	Free		Stop	
Grade		0%	0%		0%	
Peak Hour Factor	0.92	0.92	0.92	0.92	0.92	0.92
Hourly flow rate (vph)	0	433	684	29	0	43
Pedestrians						
Lane Width (ft)						
Walking Speed (ft/s)						
Percent Blockage						
Right turn flare (veh)						
Median type		None	None			
Median storage (veh)						
Upstream signal (ft)			700			
pX, platoon unblocked	0.92				0.92	0.92
vC, conflicting volume	713				915	356
vC1, stage 1 conf vol						
vC2, stage 2 conf vol						
vCu, unblocked vol	517				736	130
tC, single (s)	4.1				6.8	6.9
tC, 2 stage (s)						
tF (s)	2.2				3.5	3.3
p0 queue free %	100				100	95
cM capacity (veh/h)	963				326	825
Direction, Lane #	EB 1	EB 2	WB 1	WB 2	SB 1	
Volume Total	216	216	456	257	43	
Volume Left	0	0	0	0	0	
Volume Right	0	0	0	29	43	
cSH	1700	1700	1700	1700	825	
Volume to Capacity	0.13	0.13	0.27	0.15	0.05	
Queue Length 95th (ft)	0	0	0	0	4	
Control Delay (s)	0.0	0.0	0.0	0.0	9.6	
Lane LOS					A	
Approach Delay (s)	0.0		0.0		9.6	
Approach LOS					A	
<b>Intersection Summary</b>						
Average Delay			0.3			
Intersection Capacity Utilization			28.2%		ICU Level of Service	A
Analysis Period (min)			15			









HCM Unsignalized Intersection Capacity Analysis  
 12: Valencia Road & Val Dwy 1

8/17/2015

						
Movement	EBL	EBT	WBT	WBR	SBL	SBR
Lane Configurations		↑↑	↑↑			↑
Traffic Volume (veh/h)	0	398	643	26	0	40
Future Volume (Veh/h)	0	398	643	26	0	40
Sign Control		Free	Free		Stop	
Grade		0%	0%		0%	
Peak Hour Factor	0.92	0.92	0.92	0.92	0.92	0.92
Hourly flow rate (vph)	0	433	699	28	0	43
Pedestrians						
Lane Width (ft)						
Walking Speed (ft/s)						
Percent Blockage						
Right turn flare (veh)						
Median type		None	None			
Median storage (veh)						
Upstream signal (ft)			1070			
pX, platoon unblocked						
vC, conflicting volume	727				930	364
vC1, stage 1 conf vol						
vC2, stage 2 conf vol						
vCu, unblocked vol	727				930	364
tC, single (s)	4.1				6.8	6.9
tC, 2 stage (s)						
tF (s)	2.2				3.5	3.3
p0 queue free %	100				100	93
cM capacity (veh/h)	872				266	633
Direction, Lane #	EB 1	EB 2	WB 1	WB 2	SB 1	
Volume Total	216	216	466	261	43	
Volume Left	0	0	0	0	0	
Volume Right	0	0	0	28	43	
cSH	1700	1700	1700	1700	633	
Volume to Capacity	0.13	0.13	0.27	0.15	0.07	
Queue Length 95th (ft)	0	0	0	0	5	
Control Delay (s)	0.0	0.0	0.0	0.0	11.1	
Lane LOS					B	
Approach Delay (s)	0.0		0.0		11.1	
Approach LOS					B	
<b>Intersection Summary</b>						
Average Delay			0.4			
Intersection Capacity Utilization			28.6%		ICU Level of Service	A
Analysis Period (min)			15			









HCM Unsignalized Intersection Capacity Analysis  
 15: Wade Road & Wade Dwy 3

8/17/2015

						
Movement	EBL	EBR	NBL	NBT	SBT	SBR
Lane Configurations						
Traffic Volume (veh/h)	0	42	49	0	0	0
Future Volume (Veh/h)	0	42	49	0	0	0
Sign Control	Stop			Free	Free	
Grade	0%			0%	0%	
Peak Hour Factor	0.92	0.92	0.92	0.92	0.92	0.92
Hourly flow rate (vph)	0	46	53	0	0	0
Pedestrians						
Lane Width (ft)						
Walking Speed (ft/s)						
Percent Blockage						
Right turn flare (veh)						
Median type				None	None	
Median storage (veh)						
Upstream signal (ft)				751		
pX, platoon unblocked						
vC, conflicting volume	106	0	0			
vC1, stage 1 conf vol						
vC2, stage 2 conf vol						
vCu, unblocked vol	106	0	0			
tC, single (s)	6.4	6.2	4.1			
tC, 2 stage (s)						
tF (s)	3.5	3.3	2.2			
p0 queue free %	100	96	97			
cM capacity (veh/h)	863	1085	1623			
Direction, Lane #	EB 1	NB 1	SB 1			
Volume Total	46	53	0			
Volume Left	0	53	0			
Volume Right	46	0	0			
cSH	1085	1623	1700			
Volume to Capacity	0.04	0.03	0.00			
Queue Length 95th (ft)	3	3	0			
Control Delay (s)	8.5	7.3	0.0			
Lane LOS	A	A				
Approach Delay (s)	8.5	7.3	0.0			
Approach LOS	A					
<b>Intersection Summary</b>						
Average Delay			7.8			
Intersection Capacity Utilization			13.3%	ICU Level of Service		A
Analysis Period (min)			15			









HCM Unsignalized Intersection Capacity Analysis  
 17: Wade Road & Wade Dwy 2

8/17/2015

						
Movement	EBL	EBR	NBL	NBT	SBT	SBR
Lane Configurations						
Traffic Volume (veh/h)	0	43	50	49	42	0
Future Volume (Veh/h)	0	43	50	49	42	0
Sign Control	Stop			Free	Free	
Grade	0%			0%	0%	
Peak Hour Factor	0.92	0.92	0.92	0.92	0.92	0.92
Hourly flow rate (vph)	0	47	54	53	46	0
Pedestrians						
Lane Width (ft)						
Walking Speed (ft/s)						
Percent Blockage						
Right turn flare (veh)						
Median type				None	None	
Median storage (veh)						
Upstream signal (ft)				491		
pX, platoon unblocked						
vC, conflicting volume	207	46	46			
vC1, stage 1 conf vol						
vC2, stage 2 conf vol						
vCu, unblocked vol	207	46	46			
tC, single (s)	6.4	6.2	4.1			
tC, 2 stage (s)						
tF (s)	3.5	3.3	2.2			
p0 queue free %	100	95	97			
cM capacity (veh/h)	754	1023	1562			
<b>Direction, Lane #</b>	<b>EB 1</b>	<b>NB 1</b>	<b>SB 1</b>			
Volume Total	47	107	46			
Volume Left	0	54	0			
Volume Right	47	0	0			
cSH	1023	1562	1700			
Volume to Capacity	0.05	0.03	0.03			
Queue Length 95th (ft)	4	3	0			
Control Delay (s)	8.7	3.9	0.0			
Lane LOS	A	A				
Approach Delay (s)	8.7	3.9	0.0			
Approach LOS	A					
<b>Intersection Summary</b>						
Average Delay			4.1			
Intersection Capacity Utilization			22.0%	ICU Level of Service		A
Analysis Period (min)			15			

HCM Unsignalized Intersection Capacity Analysis  
 19: Wade Road & Wade Dwy 1

8/17/2015

						
Movement	EBL	EBR	NBL	NBT	SBT	SBR
Lane Configurations						
Traffic Volume (veh/h)	0	44	50	99	85	0
Future Volume (Veh/h)	0	44	50	99	85	0
Sign Control	Stop			Free	Free	
Grade	0%			0%	0%	
Peak Hour Factor	0.92	0.92	0.92	0.92	0.92	0.92
Hourly flow rate (vph)	0	48	54	108	92	0
Pedestrians						
Lane Width (ft)						
Walking Speed (ft/s)						
Percent Blockage						
Right turn flare (veh)						
Median type				None	None	
Median storage (veh)						
Upstream signal (ft)				361		
pX, platoon unblocked						
vC, conflicting volume	308	92	92			
vC1, stage 1 conf vol						
vC2, stage 2 conf vol						
vCu, unblocked vol	308	92	92			
tC, single (s)	6.4	6.2	4.1			
tC, 2 stage (s)						
tF (s)	3.5	3.3	2.2			
p0 queue free %	100	95	96			
cM capacity (veh/h)	660	965	1503			
<b>Direction, Lane #</b>	<b>EB 1</b>	<b>NB 1</b>	<b>SB 1</b>			
Volume Total	48	162	92			
Volume Left	0	54	0			
Volume Right	48	0	0			
cSH	965	1503	1700			
Volume to Capacity	0.05	0.04	0.05			
Queue Length 95th (ft)	4	3	0			
Control Delay (s)	8.9	2.7	0.0			
Lane LOS	A	A				
Approach Delay (s)	8.9	2.7	0.0			
Approach LOS	A					
<b>Intersection Summary</b>						
Average Delay			2.9			
Intersection Capacity Utilization			24.6%	ICU Level of Service		A
Analysis Period (min)			15			

HCM Unsignalized Intersection Capacity Analysis  
 21: Star Diamond Place & Valencia Road











8/17/2015

	→	↘	↙	↗	←	↖	↘
Movement	EBT	EBR	WBU	WBL	WBT	NBL	NBR
Lane Configurations	↑↑			↘	↑↑	↘	
Traffic Volume (veh/h)	348	10	45	10	631	5	5
Future Volume (Veh/h)	348	10	45	10	631	5	5
Sign Control	Free				Free	Stop	
Grade	0%				0%	0%	
Peak Hour Factor	0.92	0.92	0.92	0.92	0.92	0.92	0.92
Hourly flow rate (vph)	378	11	0	11	686	5	5
Pedestrians							
Lane Width (ft)							
Walking Speed (ft/s)							
Percent Blockage							
Right turn flare (veh)							
Median type	None				None		
Median storage (veh)							
Upstream signal (ft)							
pX, platoon unblocked			0.00				
vC, conflicting volume			0	389		748	194
vC1, stage 1 conf vol							
vC2, stage 2 conf vol							
vCu, unblocked vol			0	389		748	194
tC, single (s)			0.0	4.1		6.8	6.9
tC, 2 stage (s)							
tF (s)			0.0	2.2		3.5	3.3
p0 queue free %			0	99		99	99
cM capacity (veh/h)			0	1166		345	814
Direction, Lane #	EB 1	EB 2	WB 1	WB 2	WB 3	NB 1	
Volume Total	252	137	11	343	343	10	
Volume Left	0	0	11	0	0	5	
Volume Right	0	11	0	0	0	5	
cSH	1700	1700	1166	1700	1700	484	
Volume to Capacity	0.15	0.08	0.01	0.20	0.20	0.02	
Queue Length 95th (ft)	0	0	1	0	0	2	
Control Delay (s)	0.0	0.0	8.1	0.0	0.0	12.6	
Lane LOS			A			B	
Approach Delay (s)	0.0		0.1			12.6	
Approach LOS						B	
<b>Intersection Summary</b>							
Average Delay			0.2				
Intersection Capacity Utilization			27.4%		ICU Level of Service		A
Analysis Period (min)			15				

Queues

3: Camino Verde & Valencia Road

8/17/2015

										
Lane Group	EBL	EBT	WBL	WBT	WBR	NBL	NBT	NBR	SBL	SBT
Lane Group Flow (vph)	134	356	228	545	141	20	63	117	87	495
v/c Ratio	0.40	0.35	0.57	0.56	0.25	0.08	0.12	0.20	0.17	0.88
Control Delay	18.7	19.2	21.2	22.7	3.3	12.7	18.0	2.1	12.5	37.7
Queue Delay	0.0	0.0	0.0	0.0	0.0	0.0	0.0	0.0	0.0	0.0
Total Delay	18.7	19.2	21.2	22.7	3.3	12.7	18.0	2.1	12.5	37.7
Queue Length 50th (ft)	31	56	56	96	0	4	18	0	20	148
Queue Length 95th (ft)	62	90	101	142	24	15	44	14	43	#316
Internal Link Dist (ft)		2544		1040			1270			1115
Turn Bay Length (ft)	400		190		190	200		200	350	
Base Capacity (vph)	331	1005	400	980	565	250	530	576	515	561
Starvation Cap Reductn	0	0	0	0	0	0	0	0	0	0
Spillback Cap Reductn	0	0	0	0	0	0	0	0	0	0
Storage Cap Reductn	0	0	0	0	0	0	0	0	0	0
Reduced v/c Ratio	0.40	0.35	0.57	0.56	0.25	0.08	0.12	0.20	0.17	0.88

Intersection Summary









# 95th percentile volume exceeds capacity, queue may be longer.  
 Queue shown is maximum after two cycles.



Queues

6: Wade Road & Valencia Road

8/17/2015

									
Lane Group	EBL	EBT	EBR	WBL	WBT	NBL	NBT	SBL	SBT
Lane Group Flow (vph)	75	317	33	168	838	29	107	100	41
v/c Ratio	0.55	0.30	0.06	0.30	0.55	0.13	0.37	0.44	0.12
Control Delay	38.6	17.3	0.2	13.0	13.1	25.4	12.1	28.2	21.0
Queue Delay	0.0	0.0	0.0	0.0	0.0	0.0	0.0	0.0	0.0
Total Delay	38.6	17.3	0.2	13.0	13.1	25.4	12.1	28.2	21.0
Queue Length 50th (ft)	21	42	0	30	93	9	4	32	12
Queue Length 95th (ft)	#86	85	0	68	151	31	43	74	35
Internal Link Dist (ft)		280			2544		1230		281
Turn Bay Length (ft)	200		150	500		400			
Base Capacity (vph)	156	1215	640	561	1875	608	617	440	637
Starvation Cap Reductn	0	0	0	0	0	0	0	0	0
Spillback Cap Reductn	0	0	0	0	0	0	0	0	0
Storage Cap Reductn	0	0	0	0	0	0	0	0	0
Reduced v/c Ratio	0.48	0.26	0.05	0.30	0.45	0.05	0.17	0.23	0.06

Intersection Summary

# 95th percentile volume exceeds capacity, queue may be longer.  
 Queue shown is maximum after two cycles.

**Appendix E: Cultural Resources Survey**

**CULTURAL RESOURCES SURVEY OF  
DREXEL QUARTER PROJECT  
NEAR TUCSON, PIMA COUNTY, ARIZONA**

**Submitted to:**

**The WLB Group  
4444 E. Broadway  
Tucson, AZ 85711**

**Submitted by**

**Professional Archaeological Services of Tucson  
5036 Golder Ranch Rd.  
Tucson, AZ 85739-4265**

**Prepared by**

**David V.M. Stephen Ph.D.  
Principal Investigator  
State Antiquities Permit No. 2005-42b1**

**P.A.S.T. Cultural Resources Report No. 051745**

**1/6/2006**

# P.A.S.T. ABSTRACT & PROJECT SUMMARY FORM

P.A.S.T. JOB NO. 051745

**SUMMARY.** An on-foot cultural resources survey of private property (160 acres) near Tucson in Pima County identified cultural resource AZ AA:16:493 (ASM). Based on prior fieldwork and archival documentation, further cultural resource studies do not appear to be warranted on the property because the information potential of AZ AA:16:493 (ASM) has been exhausted through the formal recording of the site with the Arizona State Museum.

INTRODUCTION			
Cultural Resources Survey Of Drexel Quarter Project			
Near Tucson, Pima County, AZ.			(D2) 1/6/2006
(D3) Agency Name:			
(D4) ASM Permit No.	2005-42bl	Other Permits:	NA
(D5) Project Description:	The land is slated for residential development.		
(D6) Agency Reference:			
Project Sponsor:	The WLB Group		
(D7) PROJECT LOCATION INFORMATION (see also attached copy of USGS map)			
County:	Pima	Vicinity of	Tucson AZ
Legal:	NE4 Sec. 9 T15S R12E G&SRB&M		
AZ QUAD	USGS MAP NAME	MAP SCALE	
I. AA:16 NE	Cat Mountain	7.5'	
(D8) SURVEY INFORMATION			
Type:	Non-collection on-foot survey with systematic 20m transects or equal	Person-days	3
160 acres AND/OR 0 miles long BY 0 foot wide right-of-way		Percent surveyed	100%
Land Ownership	private		
Field Crew	J. Jones	Project Director:	David Stephen
Field Work Dates	October 9 & 16, 2005	Ground visibility was effected	(mildly) moderately
Additional Survey Records Submitted:	None	Artifact Collections Submitted to ASM:	None
(D9-10) CULTURAL RESOURCES WITHIN PROJECT AREA (see report narrative for additional information)			
Archives Researched:	ASM/AZSITE <input checked="" type="checkbox"/>	SHPO <input type="checkbox"/>	GLO <input type="checkbox"/> MNA <input type="checkbox"/> Other:
Numbers of eligible sites	NA	Numbers of ineligible sites	AZ AA:16:493 (ASM)
Previously recorded sites	NA	New sites found this project	AZ AA:16:493 (ASM)
Artifact scatters	NONE	Total sites	1
Sites within 100 meters	NONE	Isolate density/total artifacts	<1 per acre 8
Sites in 1.6 km radius	AA:16: 57, 98, 99, 100, 101, 102, 103, 106, 141, 158, 379, 422, 463, 464		
Ref. No. of Prior Surveys	NONE		
(D11) RECOMMENDATIONS FOR FURTHER WORK (see also comments below)			
FURTHER WORK RECOMMENDED	NONE <input type="checkbox"/> OR		
SITE RECORDING <input checked="" type="checkbox"/>	<input type="checkbox"/>	SUB-SURFACE TESTING <input type="checkbox"/>	DATA RECOVERY <input type="checkbox"/>
COMMENTS (see report narrative additional information)			
The quantity of artifacts within the subject property and data about known sites suggests the undertaking will impact no important cultural resources. The information potential of the cultural resources encountered (AZ AA:16:493 (ASM)) has been exhausted through the recordation activities. The project sponsor should be allowed to develop the subject property without further cultural resource studies.			
References (see also last page of report)			
Form Completed By	David Stephen	Form Rev. 1/02	Date 1/6/2006

**Cultural Resources Survey Of  
Drexel Quarter Project  
Near Tucson, Pima County, Arizona  
PAST No. 051745**

**Introduction.**

Personnel from P.A.S.T. reviewed field and archival information for a 3 person-day, survey of the Drexel Quarter property conducted on October 9 & 16, 2005 located in Pima County near Tucson in anticipation of residential development. The purpose of the project was to determine whether any significant cultural resources that might be adversely impacted by construction were present. The project sponsor (The WLB Group) initiated this study in accordance with municipal requirements. P.A.S.T. holds permit 2005-42bl issued under the Arizona Antiquities Act through the Arizona State Museum.

**Project Location.**

The approximately 160 acre project area is located in the south western portion of the Tucson Basin (Figure 1). The location with respect to the Public Land Survey is within the NE4 of section 9 T15S R12E G&SRB&M. The project area is located on the Cat Mountain United States Geological Survey 7.5' map. The UTM values for selected boundary points are shown on the map to indicate the extent of the parcel. The boundary shown on the map is reasonably accurate given the limitations of a 1:24,000 scale map. It is based on data and maps provided by the client as well as field observations but it is not intended to represent the precise legal extent of the parcel. Unless otherwise noted, land ownership coincides with the parcel and survey boundary shown in Figure 1. The fieldwork was conducted on private lands.

**Base Maps Included In Report**

Figure 1 is a copy of a portion of the U.S.G.S. Cat Mountain 7.5-minute topographic map that shows the project boundaries (including UTM values), archaeological sites within the project area, and all isolated artifacts and features found during the survey.

Figure 2 is a site map depicting the site boundary, appropriate natural features and major elements of the site.

**BACKGROUND TO STUDY AREA:**

**Records Review.**

A review of the records of the Arizona State Museum (ASM), in anticipation of the survey indicated that the subject parcel or adjacent lands had undergone an archaeological survey. This fieldwork (cite) revealed that cultural resources (AZ AA:16:493 (ASM)) were present on the subject parcel. Additional recorded cultural resources within a 1.6 kilometer radius of the center of the project area are also listed in Table A-2 and on the project summary form.

Fig. 1 U.S.G.S. 7.5' MAP Cat Mountain (AA:16 NE)

051745

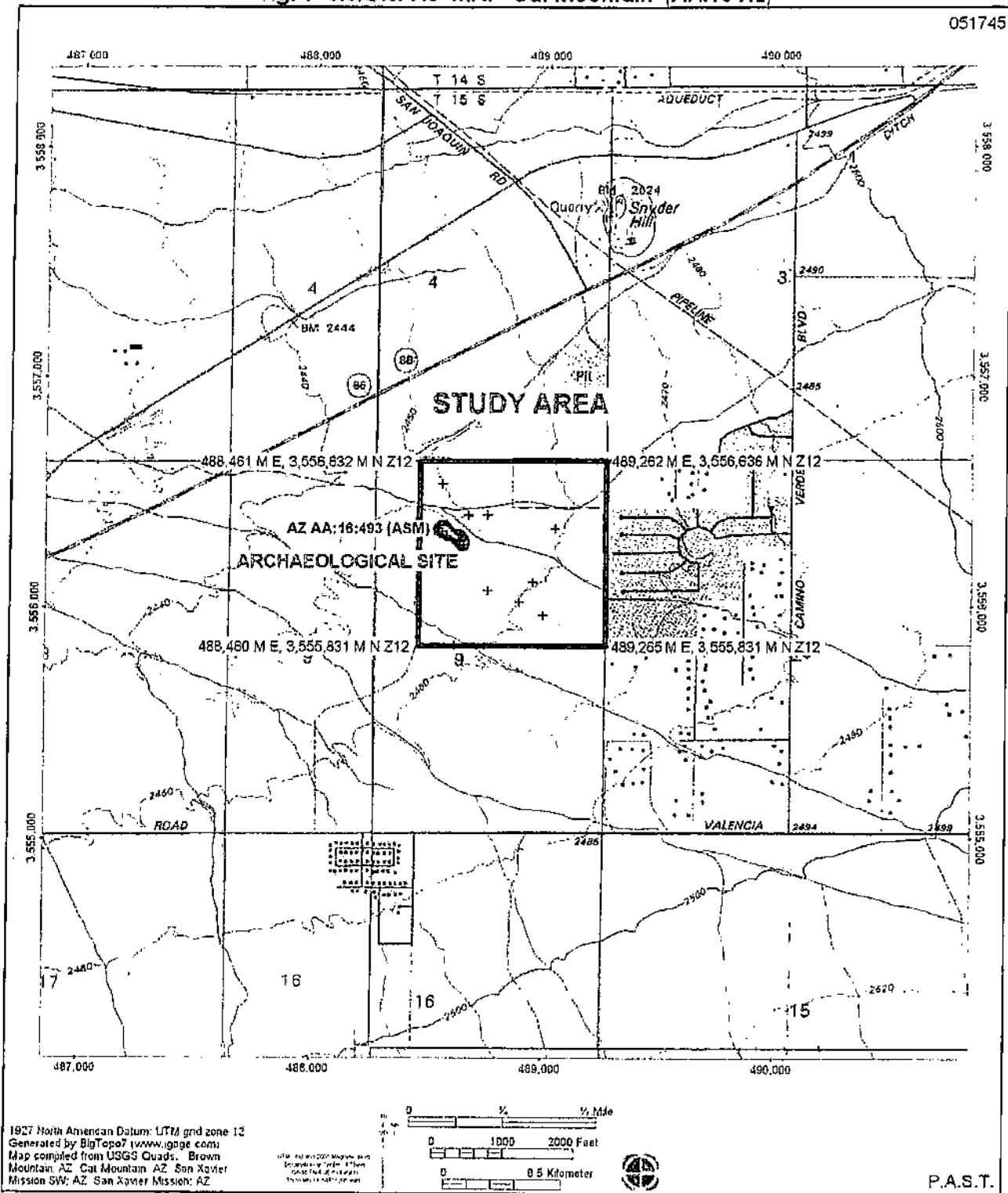

PAST No. 051745

Sec. 9 T15S R12E G&SRB&M

February, 06

NOTE: Due to the sensitivity of site locations, only sites within the project area are depicted on the map. Site locations as well as their geometric representation and extent are approximate.

P.A.S.T.  
Tucson, Arizona  
85739-4265 USA  
Telephone 520.825.3536

### **Culture History.**

The antiquity laws apply to human cultural remains in excess of 50 years of age and require them to be assessed as to their potential for yielding important information. Consequently, sites and artifacts dating from the mid twentieth century and earlier must be evaluated. The historical period that commenced in roughly 1700 is comprised of the Spanish, Mexican and Anglo occupations with some researchers recognizing the protohistoric as a transitional culture from the earlier prehistoric occupations. The prehistoric peoples who lived in this region include the Hohokam, Archaic and Paleoindian cultures.

The Hohokam (A.D. 450 - 1450). The Hohokam were a sedentary, agriculture-based people who produced both plain and decorated pottery, along with numerous other crafts of shell, stone and clay. They were skillful agriculturists who lived in houses built in shallow pits and constructed extensive irrigation canal systems. In some of the larger villages, they built ballcourts that probably served as focal points for ceremonial or recreational activities. Whether the Hohokam migrated into the region from Mexico or developed from indigenous Archaic populations is still hotly debated. The Hohokam cultural sequence was established in the 1930s based on the decorated pottery types unearthed at the Snaketown Site in the Phoenix Basin. Shortly thereafter, Isabel Kelly modified this chronology to fit the Tucson Basin sequence after her excavations at the Hodges Ruin in Tucson. Since that time, the continual acquisition of new archaeological data has brought about many refinements in the chronology.

Archaic Era (7500 B.C. - A.D. 450). The Archaic era has traditionally been characterized by assemblages of chipped stone artifacts along with ground stone tools for processing plant materials, and a lack of ceramics. Recent research in the Tucson Basin and elsewhere has demonstrated the presence of pit house villages, agriculture and some ceramics in the Late Archaic. The shift from a hunting-based economy to a reliance on plant foraging and small-game hunting that characterized the Archaic sites was caused by the extinction of Pleistocene mammals favored by the Paleoindians.

Paleo-Indian Era (ca. 10,000 - 7500 B.C.). Eleven thousand years ago, the climate in the Southwestern United States was considerably wetter and cooler than it is today, and much of the terrain consisted of lush grasslands that supported herds of mammoth, bison and other large grazing animals. Many of the earliest occupants of the area, known as Paleoindians, were hunters who subsisted on these large, late Pleistocene mammals. The belief that many of the Paleoindians were primarily big-game hunters is supported by the fact that most of the Paleo-Indian sites that have been excavated have been kill and butchering sites. The artifact assemblages from these sites are made up of projectile points and other stone tools suitable for skinning animals and cutting meat and bone. The earliest Paleo-Indian artifacts found in southern Arizona belong to the Clovis complex (9500-9000 B.C.), which is characterized by long, lanceolate, fluted Clovis points, along with other stone implements and bone artifacts.

### **Survey Expectations.**

This project's study area was located in a portion of southern Arizona that is conducive to prehistoric and/or historical settlement. Therefore, it was considered a reasonable likelihood that prehistoric or historical sites would be found during the survey.

**CULTURAL RESOURCES SURVEY:****Methods.**

The original field work consisted of an intensive on-foot coverage of the property in order to identify and locate any cultural resources, historic or prehistoric, within the property boundaries (cite). Field personnel walked transects approximately 20 meters apart and crossed the subject property in a series of contiguous corridors with any areas of extreme slope covered less intensively. Survey transects paralleled the longest dimension of the property except when prevented by the landform, vegetation density or hydrological features. Unless noted otherwise, the transect count is the quotient of the transect extent and parcel width. General conditions were good for conducting the fieldwork. Ground visibility was (mildly) affected by the presence of trees, shrubs, semi-shrubs, succulents and grasses. The original land-form was moderately disturbed by modern alterations to the ground surface.

**Survey Results.**

The information derived from the fieldwork is generally in keeping with the expectations generated from archival and literature sources. Part of the project area fell within the nominal boundary of AZ AA:16:493 (ASM). Nominally there were sufficient surface indications of archaeological materials on the property to meet the Arizona State Museum minimum standard for recording as an archaeological site.

Site description for AZ AA:16:493 (ASM). The site consists of a very light scatter of prehistoric artifacts across a 110 m by 30 m area on private lands. The vegetation at the site is not different from that described earlier for the survey area discussed above. The artifacts are associated with a deflated rock-filled roasting pit with 16 fire cracked-rocks in a 40 cm area. The roasting pit is pedestaled approximately 3 cm above a deflating ground surface and has no indications that any materials remain subsurface. It is located in a deflating area between two washes. The artifact scatter includes five basalt flakes, one Middle Rincon decorated brownware, seven discrete plainware sherds, and a cluster of 14 plainware sherds that represents what appears to be a large sherd that was recently crushed by an off road vehicle. These artifacts represent debris left behind by prehistoric people harvesting and processing resources. No artifact concentrations or other evidence of subsurface materials such as houses or armadas were observed. The site condition is not good because of erosion. The likelihood of human remains being found at this type of site is low.

**Criteria for Significance Evaluation.**

Archaeological and historical sites generally are not considered significant unless they are eligible for listing in the National Register of Historic Places. To be listed in the National Register a historic property normally must be at least 50 years of age and must be significant according to the following definition:

The quality of *significance* in American history, architecture, archaeology, and culture is present in districts, sites, buildings, structures, and objects that possess integrity of location, design, setting, materials, workmanship, feeling, and association, and:

- A) that are associated with events that have made a significant contribution to the broad patterns of our history; or



- B) that are associated with the lives of persons significant in our past; or
- C) that embody the distinctive characteristics of a type, period, or method of construction, or that represent the work of a master, or that possess high artistic values, or that represent a significant and distinguishable entity whose components may lack individual distinction; or
- D) that have yielded, or may be likely to yield, information important in prehistory or history (National Park Service 1986)

**Significance Assessment.**

Archaeological site AZ AA:16:493 (ASM) could qualify for National Register listing under criterion "D" (cited above) if it could provide new data important in prehistory or history. In order for the site to provide new cultural information about the cultural group who made and used it, it would need to retain some of its original integrity and be associable with a specific period of prehistory or history. The surface of the site has been significantly eroded since abandonment. The lack of depth to the deposits and deflation of the ground surface from hydrological processes make it unlikely the site retains sufficient physical integrity to yield meaningful information beyond that which was gathered during recordation process.

In summary archaeological site AZ AA:16:493 (ASM) contained archaeological materials that met the A.S.M. site definition standard criteria but currently does not appear to have the potential to yield information beyond that which was derived from the recording the resource.

**Eligibility Evaluation.**

Since the site has been recorded, and no important information can be obtained through further studies, P.A.S.T. recommends that AZ AA:16:493 (ASM) not be considered significant under Criterion D listed above.

**Evaluation Of Effects Of The Proposed Project.**

Considering the nature of the cultural resources found on the property and the work already completed, the development of the inspected parcel will not have an effect on potentially significant cultural resources.

**Recommendations.**

Based on the archival information, field methods, the observable surface indications and because none of the materials observed on the subject property have potential to provide important archaeological or historical information beyond what has been already obtained for this resource, P.A.S.T. supports approving the sponsor's application. Although P.A.S.T. does not endorse additional archaeological studies for this project, ground-disturbing activities on the property should not commence without authorization by the agency archaeologist(s).

There remains the possibility that ground-disturbing activities could reveal the presence of heretofore undiscovered cultural resources. If such materials are discovered construction activities should stop. Consultation should be initiated with the appropriate agency archaeologist, and if applicable under ARS §41-841 et seq. the Arizona State Museum, to assess the potential significance of any materials unearthed.

Under State law (ARS 41-§865 & §41-844) if human skeletal remains or funerary objects are discovered on either public or private lands the Arizona State Museum should be contacted immediately.

**NOTE FOR ADOT INVOLVED PROJECTS:** If previously unidentified cultural resources are encountered during activity related to the use of this source, the contractor shall stop work immediately at that location and shall take all reasonable steps to secure the preservation of those resources. The Engineer will contact the ADOT Environmental Planning Group, Historic Preservation Team at 602.712.8641 and make arrangements for the proper treatment of those resources.

**LITERATURE CITED**

National Park Service

1986 *How to Apply the National Register Criteria for Evaluation*. Department of the Interior. Copies available from Bulletin No. 16. National Register of Historic Places.

Turner, R. and D. Brown

1982 Sonoran Desertscrub. In *Biotic Communities of the American Southwest - United States and Mexico*, edited by D. Brown, pp. 118-121. University of Arizona for Boyce Thompson Southwestern Arboretum, Superior, Arizona.

## APPENDIX 1 – SUPPLEMENTARY REPORT TABLES

Table A-1. Isolates Provenience (all UTM Zone 12)				
Total isolated artifacts: 8		Isolates per acre: <1		GPS Datum: NAD27 <input checked="" type="checkbox"/> WGS84 <input type="checkbox"/>
Seq.	Easting	Northing	Kind	Comments
a	488,559	3,556,535	PS	Plainware sherd
b	488,671	3,556,398	CS	Basalt flake
c	488,757	3,556,070	CS	Metasediment flake
d	488,755	3,556,401	CS	Possible core
e	488,893	3,556,021	CS	Battered core
f	488,951	3,556,107	PS	Plainware sherd
g	488,994	3,555,967	PS	2 plainware sherds
h	489,045	3,556,342	NSF	rock pile, could be modern or prehistoric
				no associated artifacts

(Individual Artifacts: PW = PLAINWARE; DW = DECORATED; CS = CHIPPED STONE; GS = Ground STONE; FR = FAR; SH = SHELL; OR = OTHER)  
 (Non-site entities: NSS = non-site artifact scatter; NSF = non-site feature)

Table A-2. Table of Recorded Sites Within 1.6 km Radius (all G&SRB&M)	
ASM Quad	Site Numbers
AA:16	57, 98, 99, 100, 101, 102, 103, 106, 141, 158, 379, 422, 463, 464

Table A-3. Site Management Summary Table (all G&SRB&M)						
(only required when greater than 3 sites are located)						
ASM#	Status	T/R/Section	Owner-ship	Content or Age	Eligible ?	Additional Work Recommended
AZ AA:16:493	New	15S/12E/9	Private	Hohokam	No	None

Fig. 2 SITE MAP OF AZ AA:16:493 (ASM)

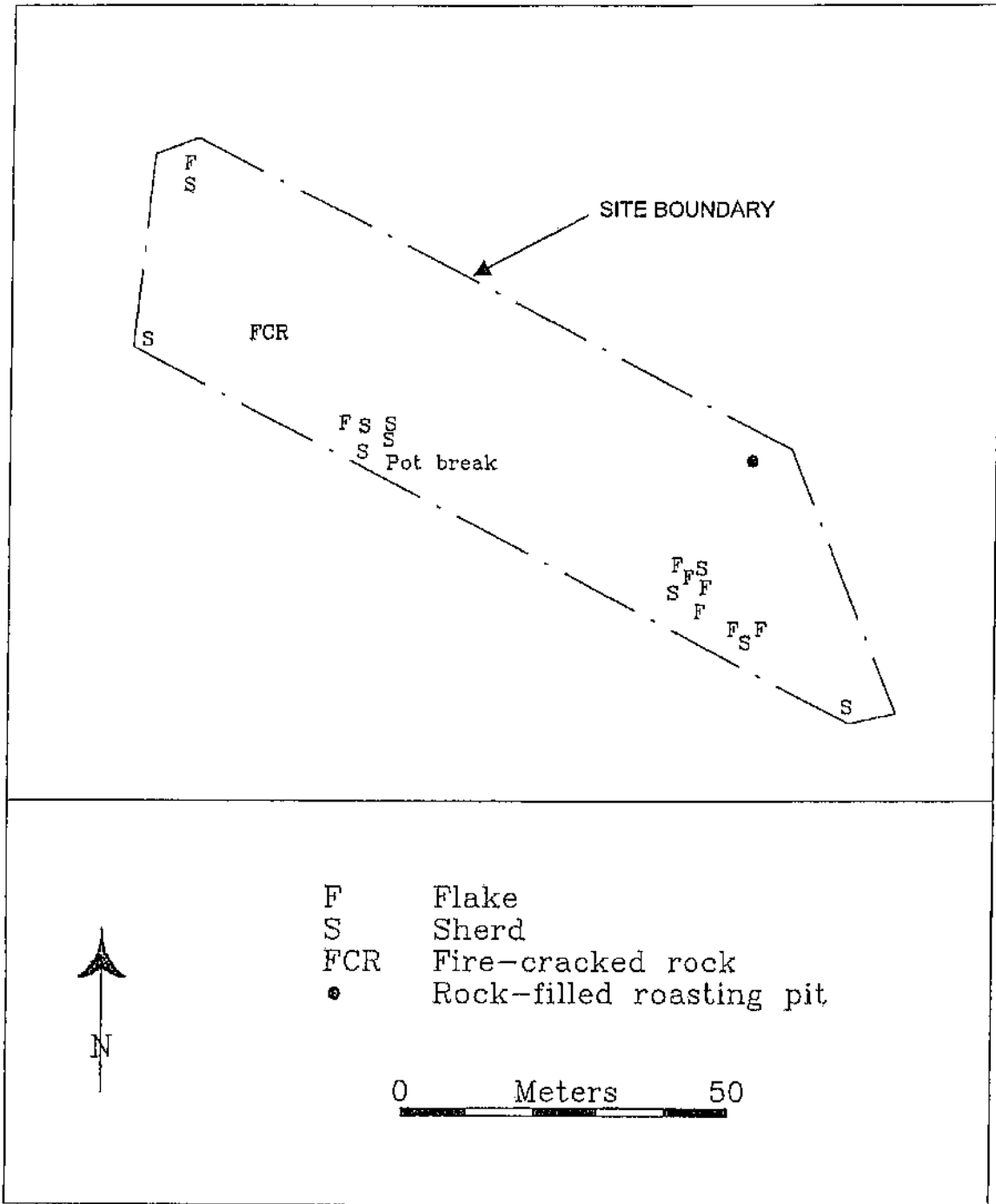

**Appendix F: Commercial Design Manual**



# Tucson Mountain Ranch Commercial Design Manual

Draft: 12/5/2017

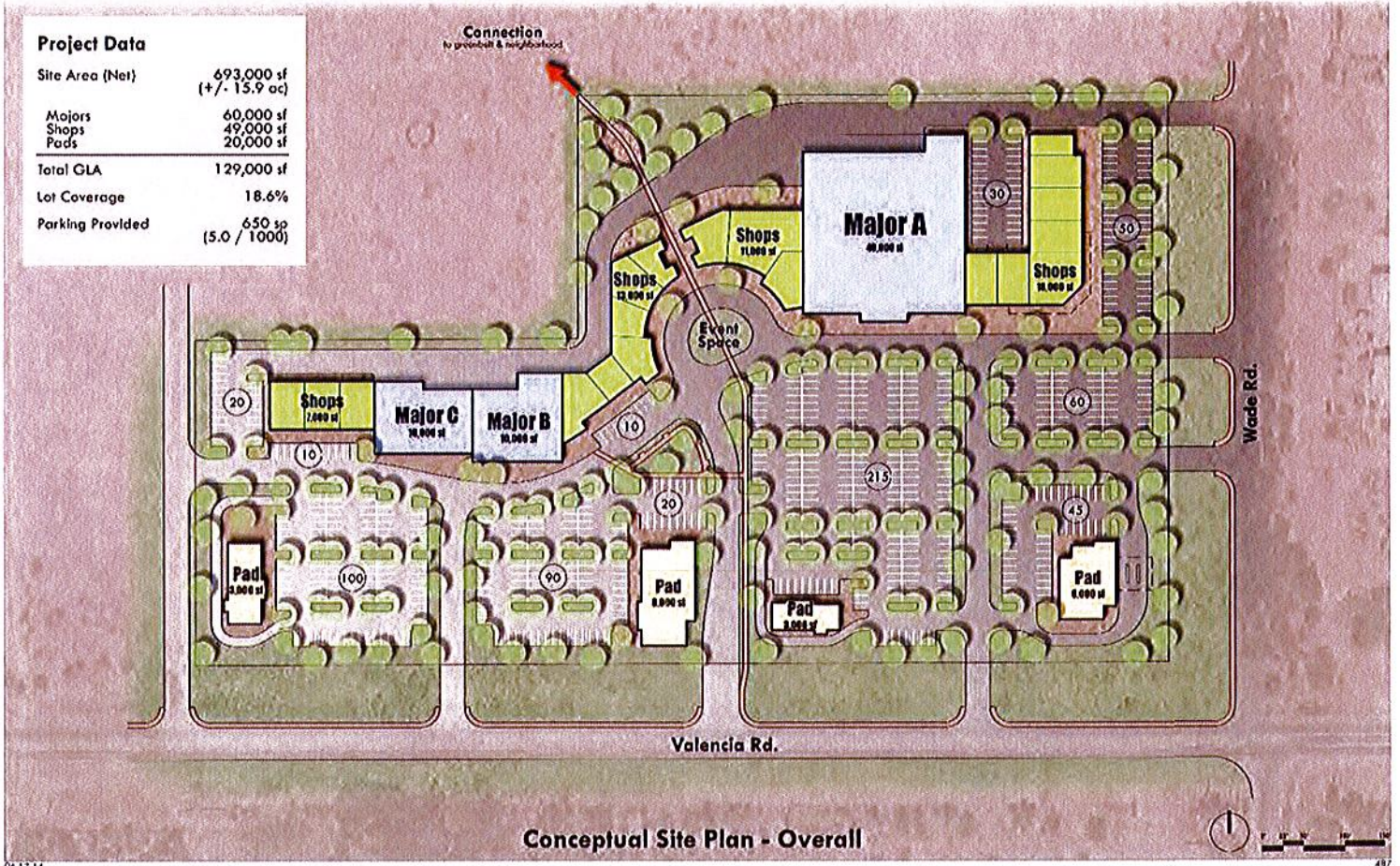

NWC Valencia Road and Wade Road  
Tucson, Arizona



This Page Intentionally Left Blank



# Table of Contents

1. Introduction .....	iii
2. Primary Building Façades & Customer Entrances .....	iv
3. Rooflines .....	v
4. Materials & Colors .....	vi
5. Secondary Building Façades (Back & Side) .....	vii
6. Outdoor Storage, Trash Collection, Loading Areas & Other Site Features .....	vii
7. Pedestrian Spaces & Circulation .....	ix