



BOARD OF SUPERVISORS AGENDA ITEM REPORT

Requested Board Meeting Date: 6/7/2022

**= Mandatory, information must be provided*

Click or tap the boxes to enter text. If not applicable, indicate "N/A".

***Title:**

P21SP00002 BRATTON ET AL. – N. RESERVATION ROAD SPECIFIC PLAN

***Introduction/Background:**

The applicant requests a specific plan rezoning of approximately 5.07 acres from the RH (Rural Homestead) to the SP (Specific Plan) zone.

***Discussion:**

The proposed specific plan rezoning is for a phased, agricultural and off-site cannabis cultivation facility. Phase I is planned for a 43,560 sq. ft. greenhouse and associated infrastructure. Phase 2 will contain a second 43,560 sq. ft. greenhouse and additional parking. The site is located in a rural area of Pima County, approximately one and one-half miles north of the T-intersection of N. Reservation Road and W. Mile Wide Road. The use is appropriate for the site's Agricultural In-Holdings designation in the Maeveen Marie Behan Conservation Lands System.

***Conclusion:**

A rezoning to the SP zone allows for cannabis cultivation and the proposal conforms with the Comprehensive Plan land use designation of Low Intensity Rural.

***Recommendation:**

Staff and the Planning and Zoning Commission recommend APPROVAL subject to standard and special conditions.

***Fiscal Impact:**

0

***Board of Supervisor District:**

1 2 3 4 5 All

Department: Development Services - Planning Telephone: 520-724-8800

Contact: Terrill L. Tillman, AICP, Principal Planner Telephone: 520-724-6921

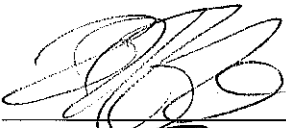
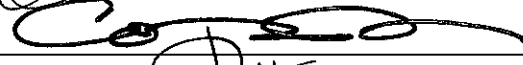
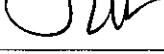
Department Director Signature:		Date:	5/16/22
Deputy County Administrator Signature:		Date:	5/17/2022
County Administrator Signature:		Date:	5/17/2022



TO: Honorable Sharon Bronson, Supervisor, District 3

FROM: Chris Poirier, Deputy Director *CC Tom Draszgowski*
Public Works-Development Services Department-Planning Division

DATE: May 17, 2022

SUBJECT: **P21SP00002 BRATTON ET AL. – N. RESERVATION ROAD SPECIFIC PLAN**

The above referenced Rezoning is within your district and is scheduled for the Board of Supervisors' **TUESDAY, JUNE 7, 2022** hearing.

REQUEST: For a **specific plan rezoning** for approximately 5.07 acres (parcel codes 208-45-004A and 208-45-005B) from the RH (Rural Homestead) zone to the SP (Specific Plan) zone, located on the west side of N. Reservation Road, approximately one and one-half miles north of the T-intersection of N. Reservation Road and W. Mile Wide Road. The proposed specific plan rezoning conforms to the Pima County Comprehensive Plan which designates the property as Low Intensity Rural.

OWNERS: Bratton, Christopher et al.
3114 E. Taurus Place
Chandler, AZ 85249

AGENT: Lazarus & Silvyn, P.C.
Attn: Robin Large and Keri Silvyn
5983 E. Grant Road, Ste. 290
Tucson, AZ 85712

DISTRICT: 3

STAFF CONTACT: Terrill L. Tillman, AICP, Principal Planner

PUBLIC COMMENT TO DATE: As of May 17, 2022, no public comment has been received.

PLANNING & ZONING COMMISSION RECOMMENDATION: **APPROVAL SUBJECT TO STANDARD AND SPECIAL CONDITIONS 8 – 0** (Commissioners Hook and Gungle were absent)

STAFF RECOMMENDATION: **APPROVAL SUBJECT TO STANDARD AND SPECIAL CONDITIONS**

MAEVEEN MARIE BEHAN CONSERVATION LANDS SYSTEM DESIGNATIONS: The subject property is located within the Maeveen Marie Behan Conservation Lands System (CLS) classified as Agricultural In-Holdings.

TD/TT/ds
Attachments



SUBJECT: P21SP00002

Page 1 of 3

FOR JUNE 7, 2022 MEETING OF THE BOARD OF SUPERVISORS

TO: HONORABLE BOARD OF SUPERVISORS

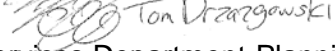
FROM: Chris Poirier, Deputy Director 
Public Works-Development Services Department-Planning Division

DATE: May 17, 2022

ADVERTISED ITEM FOR PUBLIC HEARING

SPECIFIC PLAN REZONING

P21SP00002 BRATTON ET AL. – N. RESERVATION ROAD SPECIFIC PLAN

Christopher Bratton et al., represented by Lazarus & Silvyn, P.C., request a **specific plan rezoning** for approximately 5.07 acres (parcel codes 208-45-004A and 208-45-005B) from the RH (Rural Homestead) zone to the SP (Specific Plan) zone, located on the west side of N. Reservation Road, approximately one and one-half miles north of the T-intersection of N. Reservation Road and W. Mile Wide Road. The proposed specific plan rezoning conforms to the Pima County Comprehensive Plan which designates the property as Low Intensity Rural. On motion, the Planning and Zoning Commission voted to recommend **APPROVAL SUBJECT TO STANDARD AND SPECIAL CONDITIONS 8 - 0** (Commissioners Hook and Gungle were absent). Staff recommends **APPROVAL SUBJECT TO STANDARD AND SPECIAL CONDITIONS.**

(District 3)

Planning and Zoning Commission Public Hearing Summary (April 27, 2022)

The public hearing was held virtually. Some commissioners were virtual while others attended through the telephonic option. Staff and the applicant attended and presented virtually.

Staff presented information from the staff report to the commission with a recommendation of approval subject to standard and special conditions.

A commissioner requested more details about the licensed dispensary that would allow the off-site cultivation. Staff replied that the property owner is currently working with a licensed dispensary and is unsure of the details and deferred the conversation to the applicant. The commissioner also asked about the access. Staff replied that the applicant has received a modification of street standards for the paving and will not require pavement unless for some reason the off-site cultivation site were open to the public. The commissioner stated that there will be no on-site sales. Staff affirmed the statement.

A commissioner was concerned that the newly proposed marijuana text amendment on the agenda should occur prior to the approval of the specific plan. Staff replied that the specific plan is the appropriate path at this time to establish an off-site marijuana cultivation facility. There is no reason for the applicant to wait for a text amendment to allow the use.

The applicant's representative presented additional information about the proposed project and discussed that YiLo is the identified licensed dispensary to support the off-site cultivation facility.

A commissioner clarified that an off-site cultivation facility refers to the fact that cultivation has to be tied to a licensed dispensary and in this case, it is. The applicant agreed.

A commissioner asked about the future paving of Reservation Road, the trip generation from the ten employees and questioned whether any dust mitigation would be necessary. Staff replied that the intensity and overall traffic is minimal and will not trigger any pavement requirements.

A commissioner asked about the storm water and sheet flow. The applicant clarified that there are detention areas designed to hold the water to allow the water to percolate at ground level. She further stated that the buildings will be raised 2 feet to mitigate the potential flood risk.

The hearing was opened to the public, there was no one from the public to speak and the public hearing was closed.

Commissioner Maese made a motion to recommend **APPROVAL SUBJECT TO STANDARD AND SPECIAL CONDITIONS**, Commissioner Truitt gave second.

The commission voted to recommend **APPROVAL** of the specific plan rezoning 8 – 0 (Commissioners Hook and Gungle were absent), subject to the following conditions:

IF THE DECISION IS MADE TO APPROVE THE SPECIFIC PLAN, THE FOLLOWING REQUIREMENTS SHOULD BE MADE CONDITIONS OF APPROVAL. THE FOLLOWING CONDITIONS MAY RESIDE WITHIN THE SPECIFIC PLAN DOCUMENT:

1. Not more than 60 days after the Board of Supervisors approves the specific plan, the owner(s) shall submit to the Planning Director the specific plan document, including the following conditions and any necessary revisions of the specific plan document reflecting the final actions of the Board of Supervisors, and the specific plan text and exhibits in an electronic and written format acceptable to the Planning Division.
2. In the event of a conflict between two or more requirements in this specific plan, or conflicts between the requirements of this specific plan and the Pima County Zoning Code, the specific plan shall apply.
3. This specific plan shall adhere to all applicable Pima County regulations that are not explicitly addressed within this specific plan. The specific plan's development regulations shall be interpreted to implement the specific plan or relevant Pima County regulations.
4. Transportation conditions:
 - A. Paving will be required for all handicap accessible spaces and aisles, and paving for the on-site regular parking areas and access lanes shall be required in accordance with the Subdivision and Development Street Standards requirements if the site is opened to the public for product sales.
 - B. Legal, paved, all-weather access to the nearest public paved roadway shall be provided by the owner if the site is opened to the public for product sales.
 - C. Dust control mitigation for Reservation Road shall be provided by the owner(s) on a routine schedule as identified during the permitting process.

- D. Proof of coordination with City of Tucson shall be provided to Development Services prior to the issuance of a development plan.
5. Flood Control District conditions:
 - A. Demonstrate prior to issuance of a Site Construction Permit and/or a Floodplain Use Permit the existing structures and any infrastructure that will remain onsite for this project are compliant with the Floodplain Management Ordinance. Non-compliant structures shall be modified to be compliant or removed prior to the issuance of any permits for new improvements.
 - B. First flush retention shall be provided in Low Impact Development practices distributed throughout the site.
 - C. At the time of development, the developer shall be required to select a combination of Water Conservation Measures from Table B such that the point total equals or exceeds 15 points and includes a combination of indoor and outdoor measures.
6. Environmental Planning condition: Upon the effective date of the Ordinance, the owner shall have a continuing responsibility to remove buffelgrass (*Pennisetum ciliare*) from the property. Acceptable methods of removal include chemical treatment, physical removal, or other known effective means of removal. This obligation also transfers to any future owners of property within the rezoning site and Pima County may enforce this rezoning condition against the property owner.
7. Cultural Resources condition: Prior to ground modifying activities, an on-the-ground archaeological and historic sites survey shall be conducted on the subject property. A cultural resources mitigation plan for any identified archaeological and historic sites on the subject property shall be submitted at the time of, or prior to, the submittal of any tentative plan or development plan. All work shall be conducted by an archaeologist permitted by the Arizona State Museum, or a registered architect, as appropriate. Following rezoning approval, any subsequent development requiring a grading permit will be reviewed for compliance with Pima County's cultural resources requirements under Chapter 18.81 of the Pima County Zoning Code.
8. Adherence to the specific plan document as approved at the Board of Supervisor's public hearing.
9. In the event the subject property is annexed, the property owner shall adhere to all applicable conditions, including, but not limited to, development conditions which require financial contributions to, or construction of infrastructure, including without limitation, transportation, flood control, or sewer facilities.
10. The property owner shall execute the following disclaimer regarding the Private Property Rights Protection Act: "Property Owner acknowledges that neither the rezoning of the Property nor the conditions of rezoning give Property Owner any rights, claims or causes of action under the Private Property Rights Protection Act (Arizona Revised Statutes Title 12, chapter 8, article 2.1). To the extent that the rezoning or conditions of rezoning may be construed to give Property Owner any rights or claims under the Private Property Rights Protection Act, Property Owner hereby waives any and all such rights and/or claims pursuant to A.R.S. § 12-1134(I)."

TD/TT/ds
Attachments

c: Silvyn & Lazarus, P.C.

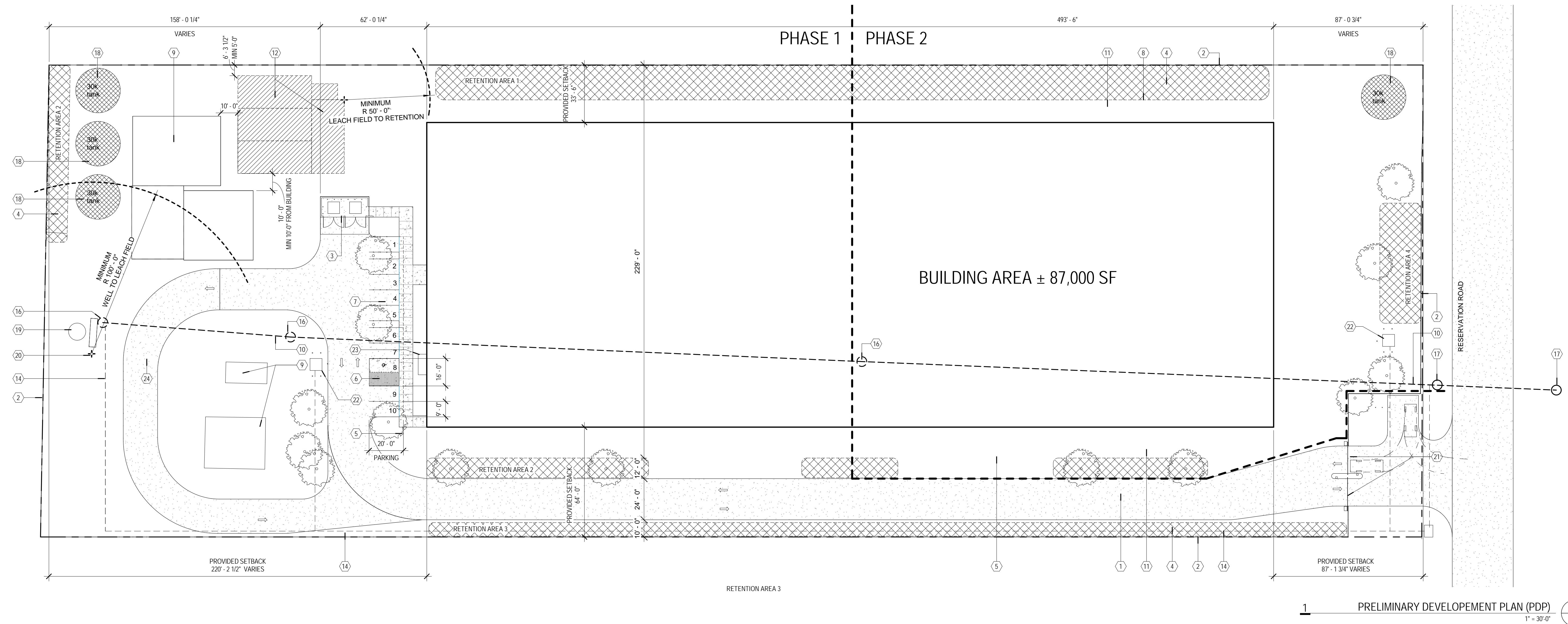

- KEYNOTES
- GRAVEL DRIVEWAY
 - 8' HIGH PERIMETER SECURITY FENCE
 - TRASH + RECYCLING
 - RETENTION BASIN
 - CONCRETE SIDEWALK
 - ACCESSIBLE PARKING WITH CONCRETE AT PARKING AND AISLE AREA
 - PARKING
 - BARRIER FENCE AT MECHANICAL YARDS
 - EXISTING BUILDINGS + STRUCTURES TO REMAIN
 - OVERHEAD ELECTRICAL TO BE RELOCATED UNDERGROUND
 - MECHANICAL AREA
 - NEW SEPTIC TANK, PRIMARY AND RESERVE LEACH FIELDS
 - NEW UNDERGROUND ELECTRIC SERVICE
 - EXISTING POWER POLE TO BE REMOVED
 - EXISTING POWER POLE
 - NEW WATER TANK
 - EXISTING WATER TANK
 - EXISTING WATER WELL/PUMP
 - AUTOMATIC GATE
 - TRANSFORMER
 - ELECTRICAL SERVICE ENTRANCE SECTION
 - ONE WAY DRIVE

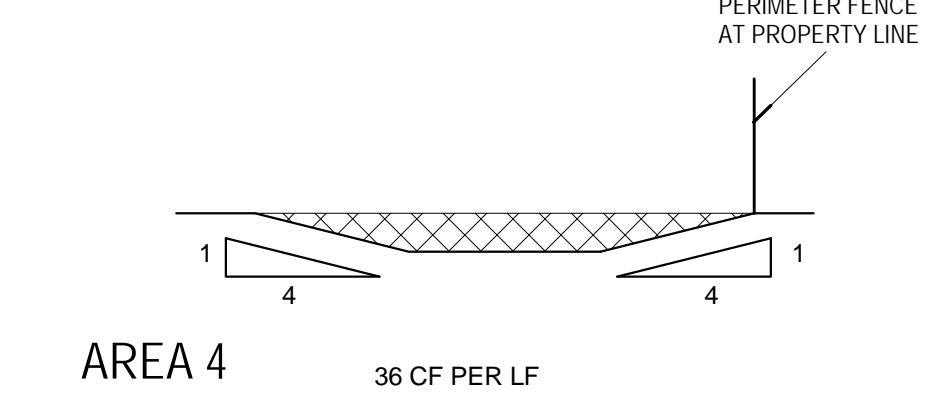
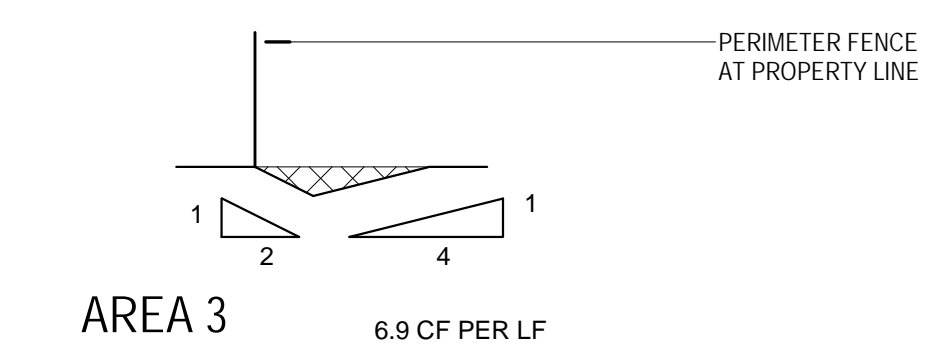
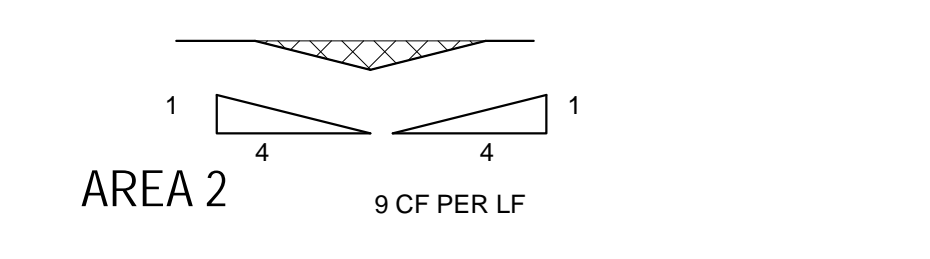
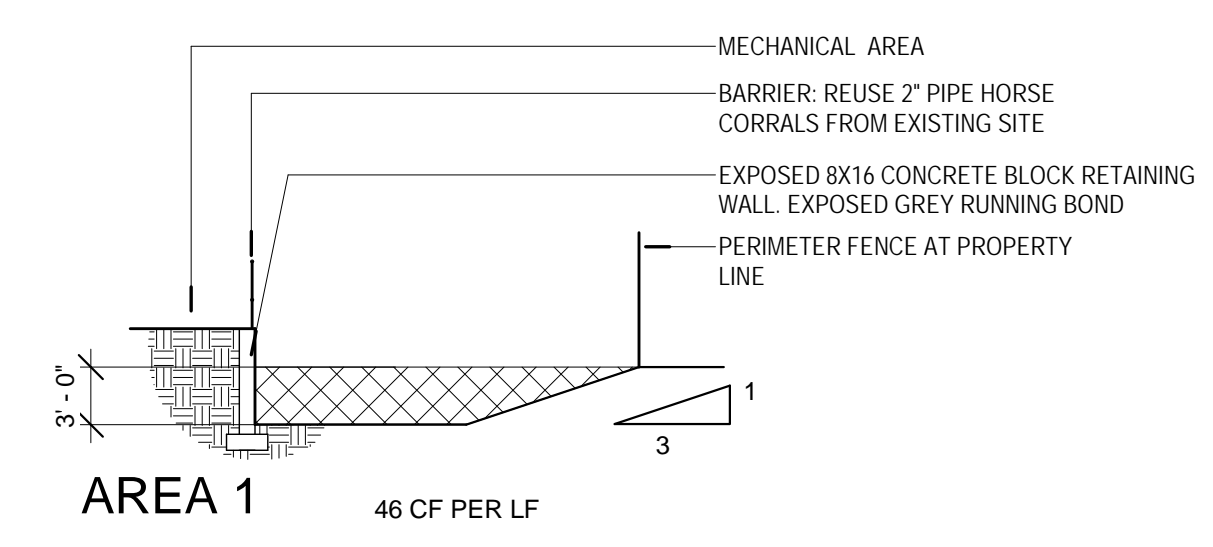

AREA 1: 46 CF/LF X 485 LF	= 22,310 CF
AREA 2: 9 CF/LF X 330 LF	= 2,970 CF
AREA 3: 6.9 CF/LF X 532 LF	= 3,670 CF
AREA 4: 36 CF/LF X 70 LF	= 2,520 CF
TOTAL	= 31,470 CF

PARKING

PHASE 1	1
ACCESSIBLE SPACE VAN (16' x 20')	9
STANDARD SPACE (8' X 20')	10
TOTAL	20

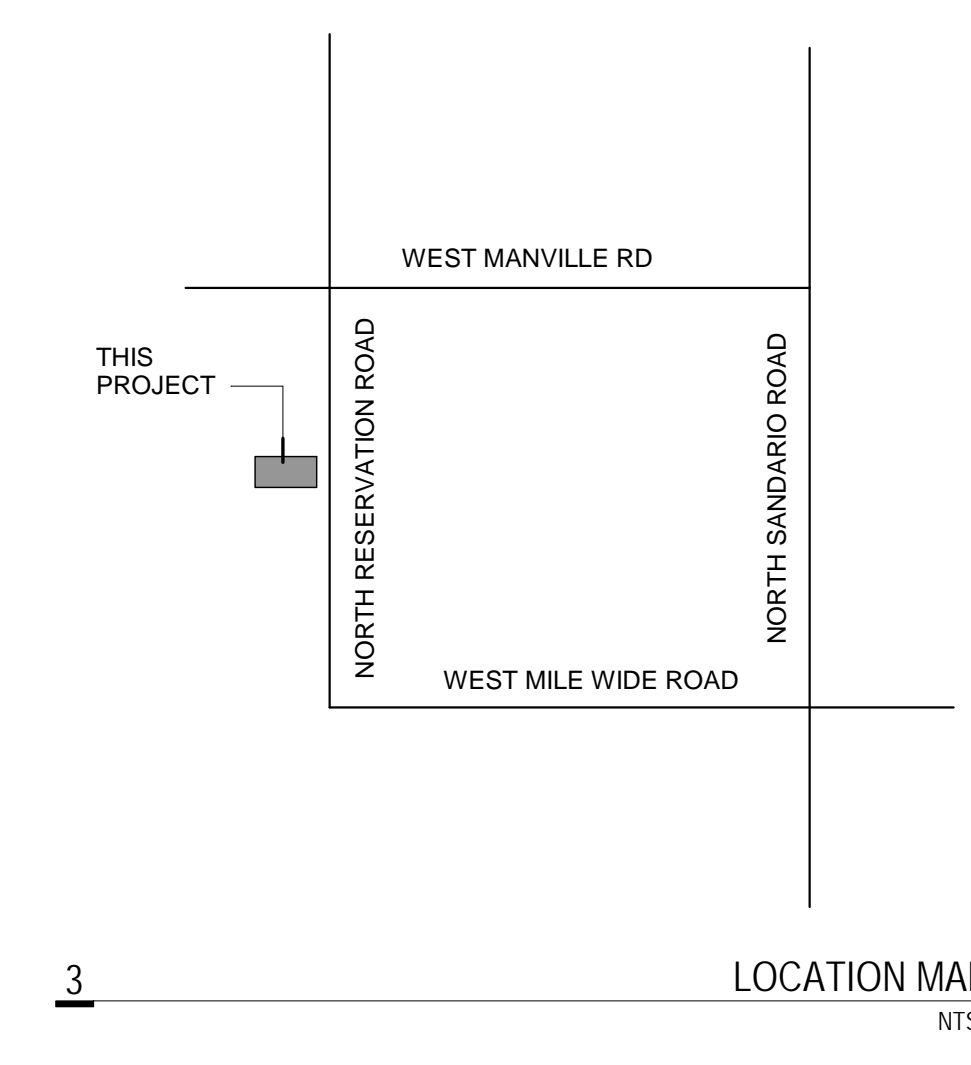

PROJECT NARRATIVE

4G GROW HOUSE WILL BE A MODERN, AUTOMATED CROP PRODUCTION FACILITY LOCATED ON SEVERAL PROPERTIES IN THE VICINITY 3601 NORTH RESERVATION RD., MARANA, PIMA COUNTY, ARIZONA. THE PROJECT CONSISTS OF ONE OR MORE METAL BUILDINGS PROVIDING APPROXIMATELY 87,000 SF TOTAL BUILDING AREA.

PARCEL NUMBERS
 MAIN PARCEL #208-45-004A
 WEST PARCEL #208-45-005B

EXISTING BUILDINGS TO REMAIN
 6,700SF

PHASING:
 THE PROJECT WILL POTENTIALLY BE BUILT IN TWO PHASES, EACH WITH METAL BUILDING APPROXIMATELY 43,500 SF.

POTENTIAL PHASE 1
 THIS PHASE WILL BE AN AGRICULTURE CROP PRODUCTION BUILDING, TARGETED AT NEW AUTOMATED VERTICAL FARMING METHODS. THIS METAL BUILDING WILL BE SIMILAR IN NATURE TO ANY OTHER METAL AGRICULTURAL BUILDING. NO MARIJUANA WILL BE GROWN UNTIL THE PHASE 2 SPECIFIC PLAN IS APPROVED. THIS PHASE WILL BE EXEMPT FROM THE PIMA COUNTY ZONING REGULATIONS AS AN AGRICULTURAL BUILDING WILL INCLUDE:

- THE WEST PORTION OF THE BUILDING.
- NEW WATER TANK FOR DOMESTIC WATER AND FIRE SUPPRESSION, SUPPLIED BY EXISTING WELL.
- NEW SEPTIC SYSTEM FOR BOTH PHASES.
- GRAVEL DRIVE AND PARKING SPACES FOR WEST BUILDING
- PERIMETER FENCE AND SECURITY GATE

POTENTIAL PHASE 2
 WILL INCLUDE:

- THE EAST PORTION OF THE BUILDING
- GRAVEL DRIVE AND PARKING SPACES FOR EAST BUILDING

ZONING PHASE 1

ZONING
 CURRENT LOT ZONING: RH
 SURROUNDING PROPERTIES ZONING: RH
 USE: VACANT
 OWNER: CITY OF TUCSON

PHASE 1 IS EXEMPT FROM ZONING REGULATIONS PER PIMA COUNTY ZONING CODE SECTION 18.01.030

THE CONCEPT OF A SINGULAR COMPACTED GRAVEL FIRE ACCESS LANE ON SOUTH AND WEST WITH HAMMERHEAD TURNAROUND HAS BEEN APPROVED BY FIRE CHIEF, AVRA VALLEY FIRE DISTRICT BRIAN DELFS HYPERLINK "MAIL TO: BDELFS@AVFIRE.ORG" BDELFS@AVFIRE.ORG

ZONING AT BUILDOUT

ZONING: SPECIFIC PLAN

SPECIFIC PLAN DEVELOPMENT STANDARDS

ITEM	MINIMUM SITE AREA	0 SF
	MINIMUM YARD SETBACK	0'-0"
	MAXIMUM HEIGHT	34'
	MAXIMUM STORES	2
	MINIMUM DISTANCE BETWEEN BUILDINGS	PER BUILDING CODE
	MAXIMUM SITE COVERAGE	NONE

USE PER SPECIFIC PLAN
 CANNABIS CULTIVATION

PARKING:
 SPECIFIC PLAN ALLOWS REQUIRED PARKING TO OVERLAP SIDEWALK BY 2.5'

STANDARD PARKING SPACES
 1 SPACE PER EMPLOYEE
 10 EMPLOYEES = 10 SPACES

ACCESSIBLE SPACES
 REQUIRED, 1 PER FIFTY STANDARD SPACES

BIKE PARKING:
 NONE REQUIRED

LANDSCAPE BUFFERS
 NO LANDSCAPE BUFFERS REQUIRED.

PDP SUBMITTAL COMMENTS	NOV 1, 2021
PDP SUBMITTAL	SEPT. 2021
PRE APPLICATION REVIEW	JAN 26, 2021
issue	date

PRELIMINARY NOT FOR CONSTRUCTION

4G FARMS

3601 NORTH RESERVATION ROAD, MARANA, AZ 85653

ROB PAULUS ARCHITECTS LTD.
 990 EAST 17TH STREET SUITE 100
 TUCSON ARIZONA 85719 520.624.9805
 WWW.ROBPAULUS.COM

© All rights reserved Rob Paulus Architects, Ltd. This drawing is an instrument of service. It is the property of Rob Paulus Architects and may not be reproduced without written permission of the architect.



A1
 PRELIMINARY DEVELOPMENT PLAN

Case #: P21SP00002
Case Name: BRATTON, ET AL. - N. RESERVATION ROAD SPECIFIC PLAN
Tax Code(s): 208-45-004A & 208-45-005B

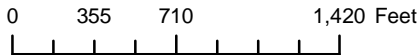
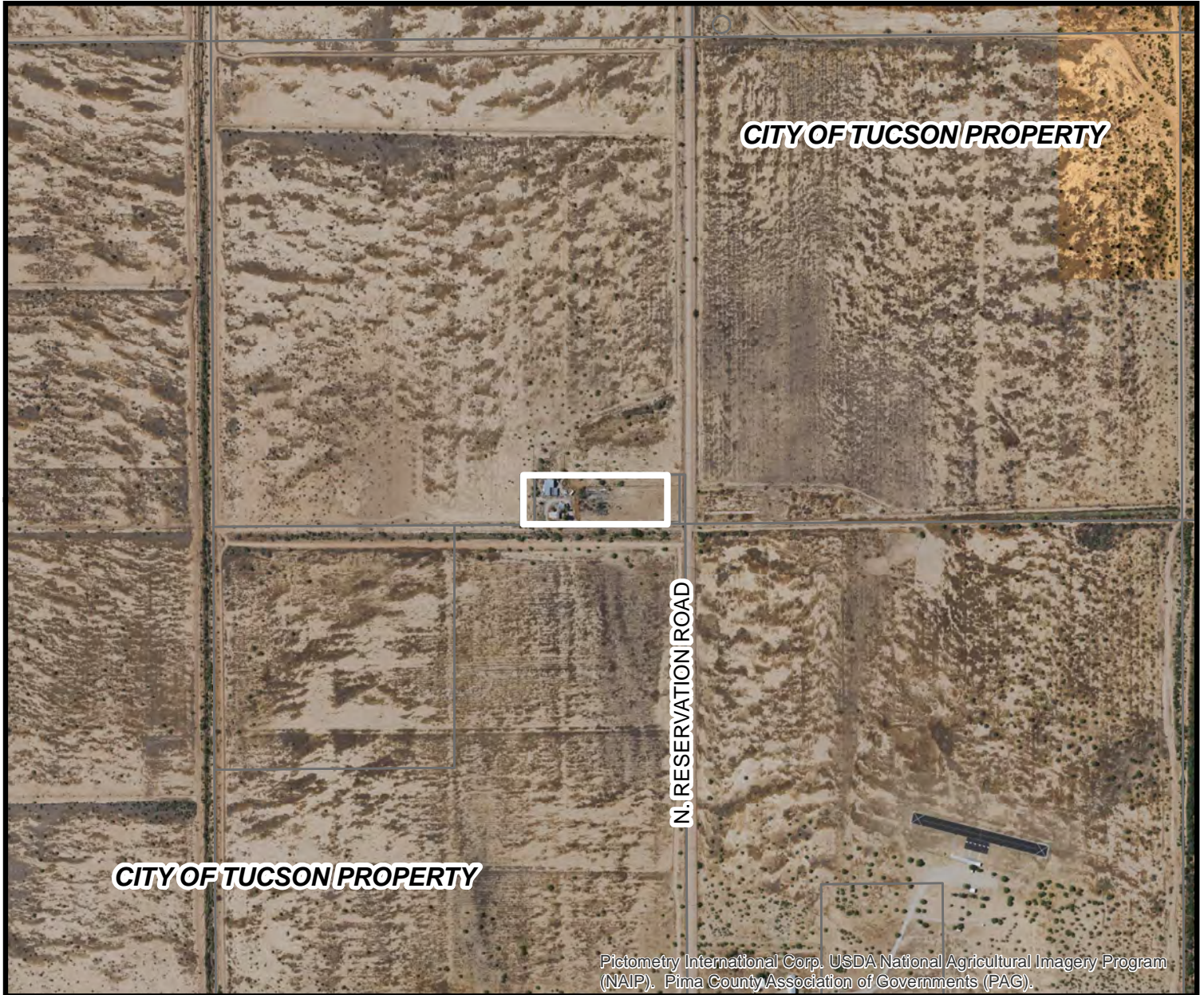
Aerial Exhibit



**PIMA COUNTY DEVELOPMENT SERVICES DEPARTMENT
PLANNING DIVISION**

	Notes:		
	Map Scale: 1:10,000	Map Date: 3/27/2022 - ds	



**SPECIFIC PLAN
PLANNING AND ZONING COMMISSION
STAFF REPORT**

HEARING DATE	April 27, 2022
CASE	P21SP00002 4G Farms Specific Plan
SUBREGION	Avra Valley Planning Area
DISTRICT	3
LOCATION	The site is located on the west side of N. Reservation Road, approximately one and one-half miles north of the T-intersection of N. Reservation Road and W. Mile Wide Road (parcel codes 208-45-004A and 208-45-005B).
ACREAGE	5.07 (+/-) acres
REQUEST	A Specific Plan rezoning from the RH (Rural Homestead) zone for Phased, Agricultural and Off-site Cannabis Cultivation
OWNER	Bratton, Christopher, et al. 3114 E. Taurus Place Chandler, AZ 85249-9693
AGENT	Lazarus & Silvyn Attn: Robin Large & Keri Silvyn 5983 E. Grant Road, Suite 290 Tucson, AZ 85712

APPLICANT'S PROPOSED USE

The applicant proposes a Specific Plan rezoning on approximately 5.07 acres for the existing residence and accessory storage buildings to remain along with a phased agricultural and off-site cannabis (marijuana) cultivation in conjunction with a licensed marijuana establishment or dispensary physically located elsewhere.

APPLICANT'S STATED REASON

"The Pima County Zoning Code ("PCZC") currently limits marijuana cultivation to the CB-2 zone. Given the Property's location and rural setting, a rezoning request to CB-2 to permit marijuana cultivation without on-site dispensary use is not appropriate. Instead, 4G Farms has opted to prepare a specific plan, which will ensure the Property will function in a manner similar to other crop production operations in a rural agricultural setting and in conformance with Proposition 207 and Arizona Department of Health Services ("DHS") regulations and guidelines. The 4G Farms Specific Plan ("Specific Plan") establishes Cannabis Cultivation as a permitted use on the Property and provides development standards that appropriately recognize the character of the Property's location and surrounding uses."

STAFF REPORT SUMMARY

Staff recommends **APPROVAL** of the 4G Farms Specific Plan subject to Section V conditions. (*Section V conditions are added to the final approved site analysis per rezoning condition #1.*) The site adheres to the Pima Prospers Comprehensive Plan Policies by supporting land uses appropriate for the rural areas of the County and by supporting the creation of a positive climate

for business. The site is classified as Agriculture In-Holdings within the Conservation Lands System (CLS) which plans for the agricultural use. Agricultural and marijuana cultivation are appropriate uses of land located within the CLS and the proposed cannabis cultivation is in conjunction with an Arizona licensed dispensary.

PUBLIC COMMENT

As of the writing of this staff report, staff has not received any public comments.

Published and mailed notice of the proposal along with the website posting of staff’s report will occur a minimum of fifteen days prior to public hearing. The website will be updated to include public comment throughout the process to the Planning and Zoning Commission and the Board of Supervisors.

COMPREHENSIVE PLAN AND REGIONAL PLAN POLICIES

The subject site’s land use designation is Low Intensity Rural (LIR). LIR designates areas for residential uses at densities consistent with rural resource-based characteristics. The agricultural uses of the site located in a rural area are considered consistent and compatible with residential uses.

The proposed uses are supported by the Comprehensive Plan Regional Policies listed below:

Use of Land:

- Use land efficiently, provide the necessary balance of uses in a compatible form, protect natural resource systems, meet social and economic needs while respecting the unique local culture and geography
- Support land uses, densities, and intensities appropriate for the urban, suburban, and rural areas of the unincorporated County
- The conservation guidelines apply to Agriculture In-Holdings within the Conservation Lands System (CLS). Development within these areas will be configured in a manner that do not compromise the conservation values of adjacent and nearby CLS lands

Economic Development Goals and Policies:

- Create a welcoming climate to new business development, outside investment, and relocation of companies and employers
- Create and maintain a positive climate for business

Housing and Community Design Element:

- Encourage green building and site design methods, techniques, and materials

The policies of Pima Prospers are implemented within the specific plan rezoning that provides compatible development in a rural area and plans for green building strategies that employ sustainable design. Some of the green building strategies include east/west building orientation for passive solar exposure, low-water use plumbing fixtures, high efficiency LED lighting, high SEER air conditioning systems and metal buildings that employ over 90% recycled steel. The use within the CLS will not compromise the adjacent and nearby CLS lands as the site was previously graded, and therefore, will not further diminish the integrity of the CLS. Most of the properties in the immediate area have been mass graded for ongoing or previous agricultural uses and serve as City of Tucson water recharge locations.

SURROUNDING LAND USES/GENERAL CHARACTER

North: RH Undeveloped Rural Agriculture

South:	RH	Undeveloped Rural Agriculture
East:	RH	Undeveloped Rural Agriculture
West:	RH	Undeveloped Rural Agriculture

The general area mostly consists of large parcels ranging from approximately 40 acres up to 316 acres owned by City of Tucson with ongoing or former agricultural uses. The nearest residential use is approximately one and one-half miles away located at the southwest corner of the unimproved W. Memory Lane and N. Trico Roads. There are many RH (Rural Homestead) zoned residential lots one and one-half miles away to the west, the result of lot splitting without a subdivision plat. The lots remain mostly vacant and unimproved likely due to the lack of infrastructure, access to utilities and sheet flooding. There are no retail services or goods, schools or churches within three miles of the site.

PREVIOUS REZONING CASES ON PROPERTY

There have been no previous rezoning cases on the site.

PREVIOUS REZONING CASES IN GENERAL AREA

Recent activity: There has not been any recent rezonings in the area.

Past activity:

Most of the properties east and west of the subject rezoning are comprised of the Saguaro National Park, West (approximately 2.07 miles east) and the Ironwood Forest National Monument (approximately .75 miles west) which were rezoned by case Co9-87-001 in 1987 from RH to IR (Institutional Reserve). Small pocket rezonings in the 70's and 80's from the RH zone to the GR-1 (Rural Residential) and SH (Suburban Homestead) zones occurred in the general area and were all greater than one-mile away.

MAEVEEN MARIE BEHAN CONSERVATION LANDS SYSTEM (CLS)

The subject property is located within the Maeveen Marie Behan Conservation Lands System classified as Agricultural In-Holdings.

PLANNING REPORT

Staff supports the request because the subject rezoning site is located in an area of the County that is surrounded by City of Tucson properties containing ongoing or previous agricultural uses, is a compatible land use in the Agricultural In-Holdings of the CLS, and the request conforms to the Pima Prospers Comprehensive Land Use Plan.

Agricultural uses that do not have a marijuana grow component may be exempted from local land use regulations under state statutory allowances if 50% of the property owner's income is derived from the agricultural use on properties 5 commercial acres (4.13+ acres) or greater. Other agricultural uses that are not statutorily exempted are permitted by right in rural zoning designations for crop production, propagation and culture without retail sales. Cannabis cultivation is regulated by the State of Arizona Department of Health Services (AZDHS), is not considered to be an agricultural crop, and therefore, is not agriculturally exempted.

In November of 2020, the Arizona legislature enacted the voter approved Proposition 207, the Smart and Safe Arizona Act (SASAA) legalizing the taxation and recreational use of marijuana for adults 21 years of age and older. Proposition 207 requires the AZDHS to regulate adult use marijuana. The SASAA also allows *adult individuals* to grow no more than six marijuana plants and no more than twelve plants per residence where there are two or more adults over the age of 21 within a secured enclosure such as a closet, room or greenhouse or other enclosure not

accessible by minors. A cultivation site is a single off-site cultivation location where marijuana may be cultivated and processed by the licensee and must take place in a secure, permanent building. A cultivation site may include the manufacture of marijuana and marijuana products that may not be transferred or sold to consumers.¹

The specific plan rezoning site contains a single-family residence and accessory buildings which will remain. Most of the site has been previously graded and therefore contains little on-site vegetation, it is flat and located within a floodplain and all structures will have a finished floor elevation 2 feet above the adjacent grade to mitigate the potential flooding risk. The project will be built out in two phases: Phase 1 will be the westernmost 43,560-square-foot building for agricultural crop production, a new water tank for water and fire suppression supplied by an existing well, a new septic system to support both phases of buildout, a gravel drive and parking spaces for the west building and a perimeter fence and security gate; Phase II will include the eastern 43,560 square-foot building and associated parking.

Any general agricultural uses on the site are exempt from zoning and building codes and will not require permits until the change of use to cannabis cultivation occurs. Once the property owner is prepared for marijuana crop production, the use will require zoning and building permits. Staff has recommended that the buildings be permitted while they undergo construction, meeting the siting demonstrated within the specific plan. The specific plan provides for adequate setbacks, however has a planned zero lot line setback along with the elimination of any bufferyard. Given the location of the project, there are no identified zoning concerns with the zero lot line setback or lack of perimeter buffering.

Access to the site will be via Reservation Road and through City of Tucson property. A shared access agreement or recorded easement to access the site across the city owned property will be required. The applicant is currently working with the City of Tucson to obtain legal access. Transportation has requested rezoning condition #4D to ensure legal access is provided.

According to the specific plan, the marijuana crop production facility will meet the safety standards set forth under the ADHS licensing. Production will be located within a secure building with controlled access to the property and buildings will contain security cameras inside and outside. The transportation of goods will be no more frequent than once every two weeks by secure vehicle. The site meets all distancing requirements from schools, parks and libraries and is completely surrounded by City of Tucson land being used for water recharge. 4G Farms will provide an odor mitigation plan to the County as part of its building permit submittal to demonstrate appropriate air filtration systems.

Concurrency of Infrastructure:

Concurrency of infrastructure exists or to serve the proposed development:

CONCURRENCY CONSIDERATIONS		
<i>Department/Agency</i>	<i>Concurrency Considerations Met: Yes / No / NA</i>	<i>Other Comments</i>
TRANSPORTATION	Yes	No objection, subject to conditions
FLOOD CONTROL	Yes	No objection, subject to conditions

CONCURRENCY CONSIDERATIONS		
WASTEWATER	N/A	Site will be served by an on-site septic system.
PARKS AND RECREATION	N/A	
WATER	Yes	Serviced by an on-site well system.
DEPARTMENT OF ENVIRONMENTAL QUALITY	Yes	No comment

TRANSPORTATION REPORT

The site is located west of N. Reservation Road with W. Manville Road approximately 1.5 miles to the north and W. Mile Wide Road approximately 1.5 miles to the south. The proposed Arizona Department of Transportation’s (ADOT) I-11 corridor is within 2,000 feet of the site.

Reservation Road is a dirt roadway maintained by the County. There is no public right-of-way (ROW) for Reservation Road south of Manville Road for approximately 2 miles, but Reservation Road was established as a 60-foot-wide roadway easement by road proceeding No. 747. The physical location of Reservation Road runs through City of Tucson-owned property, and it appears that Reservation Road was constructed outside the roadway establishment.

The boundary and topographic survey provided within the specific plan indicates that parcel 208-45-004B (located on the Reservation Road ROW but outside of the specific plan area) pertaining to the owner of the site is located within the roadway establishment. The specific plan indicates that this parcel of land will be dedicated to Pima County for ROW purposes.

The Subdivision and Development Street Standards (SDSS) requires that all commercial developments provide legal, paved access to the public roadway system. Given that the specific plan document indicates that product sales are not part of the cultivation use and 20 average daily trips (ADT) are expected on a regular basis by employees only, an administrative SDSS modification has been granted to waive the paved access until such time that the site is opened to the public. Routine maintenance and dust mitigation on Reservation Road will be required. Graveled access lanes and parking spaces are proposed, but paving will be required if the site is open to the public and for all handicap accessible spaces and aisles.

The most recent traffic counts for Reservation Road is 126 ADT, for Manville Road is 1,266 ADT, and for Mile Wide Road is 55 ADT. Given that the site will function in a manner similar to its current agricultural setting, the additional traffic generation will not negatively impact the capacity of the adjacent roadway network.

There are no concurrency concerns with this request. Proof of coordination with City of Tucson shall be provided to Development Services prior to the issuance of a development plan.

The Department of Transportation has no objection to the request subject to rezoning conditions #4A-D.

FLOOD CONTROL REPORT

The Regional Flood Control District (RFCD) offers the following comments:

1. The entire property is located within the Brawley Wash floodplain which conveys up to

21,000 cubic feet per second (cfs) and is 2.5 miles wide in this location. This property is entirely within a FEMA Flood Hazard Zone AO 1 where estimated flood depths are up to 1 foot. Any structures located within a Zone AO1 shall have a finished floor elevation 2.0 feet above highest adjacent natural grade.

2. Regulated Riparian Habitat does not impact this property.
3. The Preliminary Development Plan (PDP) does not provide the required information that is listed on the Site Analysis Checklist, including FEMA Flood Zone AO1 designation and the existing and proposed hydrology conditions.
4. There are several existing structures on the property where it is unclear if these structures are compliant with the Floodplain Management Ordinance. The District does not have floodplain use permits for any improvements on this property.
5. The design of perimeter fencing must comply with District Technical Policies. No discussion was provided in the Site Analysis.
6. The Site Analysis has not provided a "will serve" letter by a water service provider that has a potable and renewable water supply and states that there are no public providers near the project site. The property has been historically serviced with an on-site water well and will continue to use the well and have on-site storage tanks. It is not clear how much water will be utilized for this project and if the project will need to bring water in from an outside source. Land subsidence between 1987 and 2005 has been between 3 to 4 inches.
7. A condition is provided below to ensure compliance with the Water Policy of the Comprehensive Plan.

The Regional Flood Control District has no objection subject to rezoning conditions #5A-C.

WASTEWATER RECLAMATION REPORT

The property is outside of the Pima County Regional Wastewater Reclamation Department (PCRWRD) service area. The existing and proposed development on the property will be serviced by an on-site septic system.

PCRWRD has no objection to the proposed rezoning. The owner(s) must secure approval from the Pima County Department of Environmental Quality to use on-site sewage disposal system at the time a tentative plat, development plan, or request for a building permit is submitted for review.

ENVIRONMENTAL PLANNING REPORT **SITE CONSERVATION VALUES**

The 5.1-acre subject property is located entirely within the Agricultural In-Holdings designation of the Maeveen Marie Behan Conservation Lands System (CLS). The closest CLS designations outside Agricultural In-Holdings are Multi-use Management Area approx. 0.3 mile to the west and Important Riparian Area approx. 0.5 miles to the east.

The property is within the Priority Conservation Areas (PCA) for the burrowing owl and cactus ferruginous pygmy owl; it is outside PCAs for Pima pineapple cactus and needle-spined pineapple cactus.

The property has been subject to agricultural uses and was previously graded, with several existing structures on-site. It is largely devoid of native vegetation; there appear to be no saguaros or ironwoods onsite.

No washes or riparian vegetation occur onsite.

The property has not been identified as an acquisition priority under any County Open Space Bond Program.

LANDSCAPE CONTEXT

The property is surrounded on all sides by fallowed agricultural lands owned by the City of Tucson and does not occur within any identified Critical Landscape Connection. The closest County Preserve is the Brawley Wash/Manville-Garcia Preserve owned by the Regional Flood Control District 0.7 miles northeast of the property. The Ironwood Forest National Monument is 0.6 miles southwest of the property. The closest identified wildlife movement area is the Brawley Wash/Avra Valley across CAP Canal Wash Siphon to Saguaro National Park (West) Landscape Wildlife Movement Area (AGFD), which is 0.4 miles to the east of the property.

IMPACTS TO BIOLOGICAL RESOURCES

Due to extensive previous disturbance, the property has little to no on-site conservation value that would be compromised by this project. The project is also unlikely to compromise the conservation values of adjacent properties or nearby CLS-designated lands in light of its distance from any established open space preserves, identified Wildlife Movement Areas, or more protective CLS designations.

The applicant’s plan to fence the entire property causes some concern related to wildlife movement; however, considering the size of the property relative to the surrounding vacant lands and the distance from the property to any identified Wildlife Movement Areas or established Preserves, such fencing is unlikely to act as a significant barrier to wildlife moving through the valley.

OSC-Environmental Planning recommends that fully shielded, dark sky-friendly fixtures be used for all outdoor lighting fixtures, and that the reach of outdoor lighting be limited to only those areas requiring illumination to prevent light from encroaching onto adjacent lands. Overall, the use of outdoor nighttime lighting should be limited to only what is absolutely necessary to accommodate the proposed use.

Environmental Planning has no objection subject to rezoning condition #6.

CULTURAL RESOURCES REPORT

Cultural Resources has no objection to this request subject to the addition of conditions #7.

DEPARTMENT OF ENVIRONMENTAL QUALITY REPORT

Pima County Department of Environmental Quality has no comment.

NATURAL RESOURCES, PARKS AND RECREATION REPORT

Pima County Natural Resources, Parks and Recreation have no comment. Saguaro National Park and the Bureau of Land Management for the Ironwood Forest National Monument have no concern.

UNITED STATES FISH AND WILDLIFE SERVICE REPORT

US Fish and Wildlife Service have no concerns regarding the rezoning.

WATER DISTRICT REPORT

The site will be serviced by a well site permitted and regulated by the Department of Environmental Quality.

FIRE DISTRICT REPORT

Avra Valley Fire District have no comment.

CITY OF TUCSON

The City of Tucson have no comment.

TOHONO O'ODAM TRIBAL NATION DISTRICT

The Tohono O'Odham Tribal Nation have no comment.

IF THE DECISION IS MADE TO APPROVE THE SPECIFIC PLAN, THE FOLLOWING REQUIREMENTS SHOULD BE MADE CONDITIONS OF APPROVAL. THE FOLLOWING CONDITIONS MAY RESIDE WITHIN THE SPECIFIC PLAN DOCUMENT:

1. Not more than 60 days after the Board of Supervisors approves the specific plan, the owner(s) shall submit to the Planning Director the specific plan document, including the following conditions and any necessary revisions of the specific plan document reflecting the final actions of the Board of Supervisors, and the specific plan text and exhibits in an electronic and written format acceptable to the Planning Division.
2. In the event of a conflict between two or more requirements in this specific plan, or conflicts between the requirements of this specific plan and the Pima County Zoning Code, the specific plan shall apply.
3. This specific plan shall adhere to all applicable Pima County regulations that are not explicitly addressed within this specific plan. The specific plan's development regulations shall be interpreted to implement the specific plan or relevant Pima County regulations.
4. Transportation conditions:
 - A. Paving will be required for all handicap accessible spaces and aisles, and paving for the on-site regular parking areas and access lanes shall be required in accordance with the Subdivision and Development Street Standards requirements if the site is opened to the public for product sales.
 - B. Legal, paved, all-weather access to the nearest public paved roadway shall be provided by the owner if the site is opened to the public for product sales.
 - C. Dust control mitigation for Reservation Road shall be provided by the owner(s) on a routine schedule as identified during the permitting process.
 - D. Proof of coordination with City of Tucson shall be provided to Development Services prior to the issuance of a development plan.
5. Flood Control District conditions:
 - A. Demonstrate prior to issuance of a Site Construction Permit and/or a Floodplain Use Permit the existing structures and any infrastructure that will remain onsite for this project are compliant with the Floodplain Management Ordinance. Non-compliant structures shall be modified to be compliant or removed prior to the issuance of any permits for new improvements.
 - B. First flush retention shall be provided in Low Impact Development practices distributed throughout the site.
 - C. At the time of development, the developer shall be required to select a combination of Water Conservation Measures from Table B such that the point total equals or exceeds 15 points and includes a combination of indoor and outdoor measures.
6. Environmental Planning condition: Upon the effective date of the Ordinance, the owner shall have a continuing responsibility to remove buffelgrass (*Pennisetum ciliare*) from the property. Acceptable methods of removal include chemical treatment, physical removal, or other known effective means of removal. This obligation also transfers to any future owners of property within the rezoning site and Pima County may enforce this rezoning condition against the property owner.
7. Cultural Resources condition: Prior to ground modifying activities, an on-the-ground

archaeological and historic sites survey shall be conducted on the subject property. A cultural resources mitigation plan for any identified archaeological and historic sites on the subject property shall be submitted at the time of, or prior to, the submittal of any tentative plan or development plan. All work shall be conducted by an archaeologist permitted by the Arizona State Museum, or a registered architect, as appropriate. Following rezoning approval, any subsequent development requiring a grading permit will be reviewed for compliance with Pima County's cultural resources requirements under Chapter 18.81 of the Pima County Zoning Code.

8. Adherence to the specific plan document as approved at the Board of Supervisor's public hearing.
9. In the event the subject property is annexed, the property owner shall adhere to all applicable conditions, including, but not limited to, development conditions which require financial contributions to, or construction of infrastructure, including without limitation, transportation, flood control, or sewer facilities.
10. The property owner shall execute the following disclaimer regarding the Private Property Rights Protection Act: "Property Owner acknowledges that neither the rezoning of the Property nor the conditions of rezoning give Property Owner any rights, claims or causes of action under the Private Property Rights Protection Act (Arizona Revised Statutes Title 12, chapter 8, article 2.1). To the extent that the rezoning or conditions of rezoning may be construed to give Property Owner any rights or claims under the Private Property Rights Protection Act, Property Owner hereby waives any and all such rights and/or claims pursuant to A.R.S. § 12-1134(I)."

Respectfully Submitted,





Terrill L. Tillman, AICP
Principal Planner

c: Lazarus & Silvyn, Attn: Robin Large & Keri Silvyn

ⁱ Arizona Department of Health Services

Case #: P21SP00002
 Case Name: BRATTON, ET AL. - N. RESERVATION ROAD SPECIFIC PLAN
 Tax Code(s): 208-45-004A & 208-45-005B

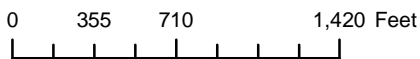
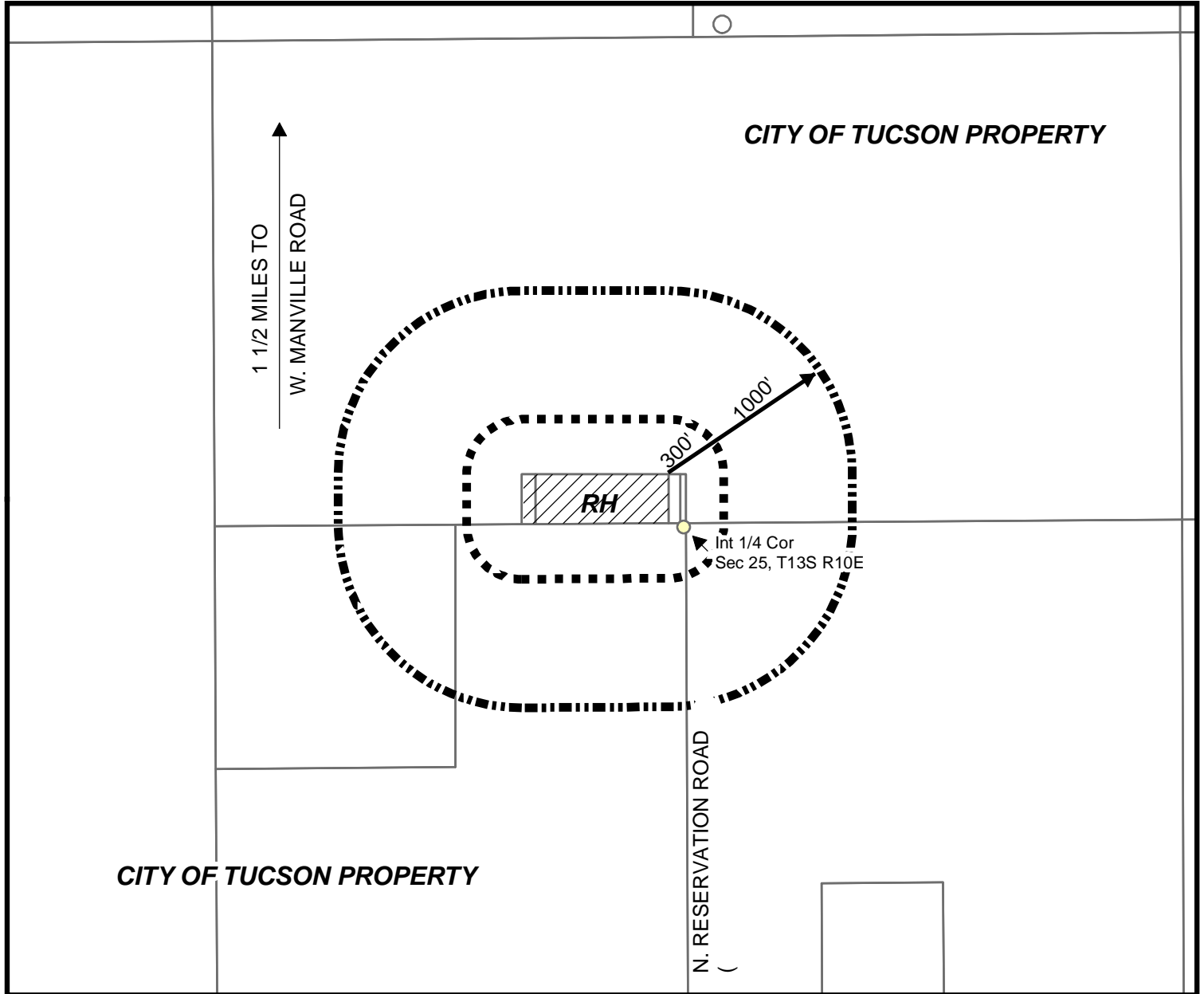

 300' Notification Area  1000' Notification Area  Zoning Boundary



Area of proposed rezoning from RH to SP



**PIMA COUNTY DEVELOPMENT SERVICES DEPARTMENT
 PLANNING DIVISION**

	Notes:			
	PIMA COUNTY COMPREHENSIVE PLAN CO7-13-10			
	Planning & Zoning Hearing: 4/27/22 (scheduled)	Board of Supervisors Hearing: TBD		
	Base Map(s): 206	Map Scale: 1:10,000	Map Date: 3/27/2022 - ds	



Land Use Legend and Map

Low Intensity Rural (LIR)



Objective: To designate areas for residential uses at densities consistent with rural and resource-based characteristics.

- Residential Gross Density: Minimum- none; Maximum- 0.3 RAC
- Residential Gross Densities for TDR Receiving Areas: Minimum- none; Maximum- 0.3 RAC

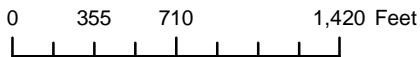
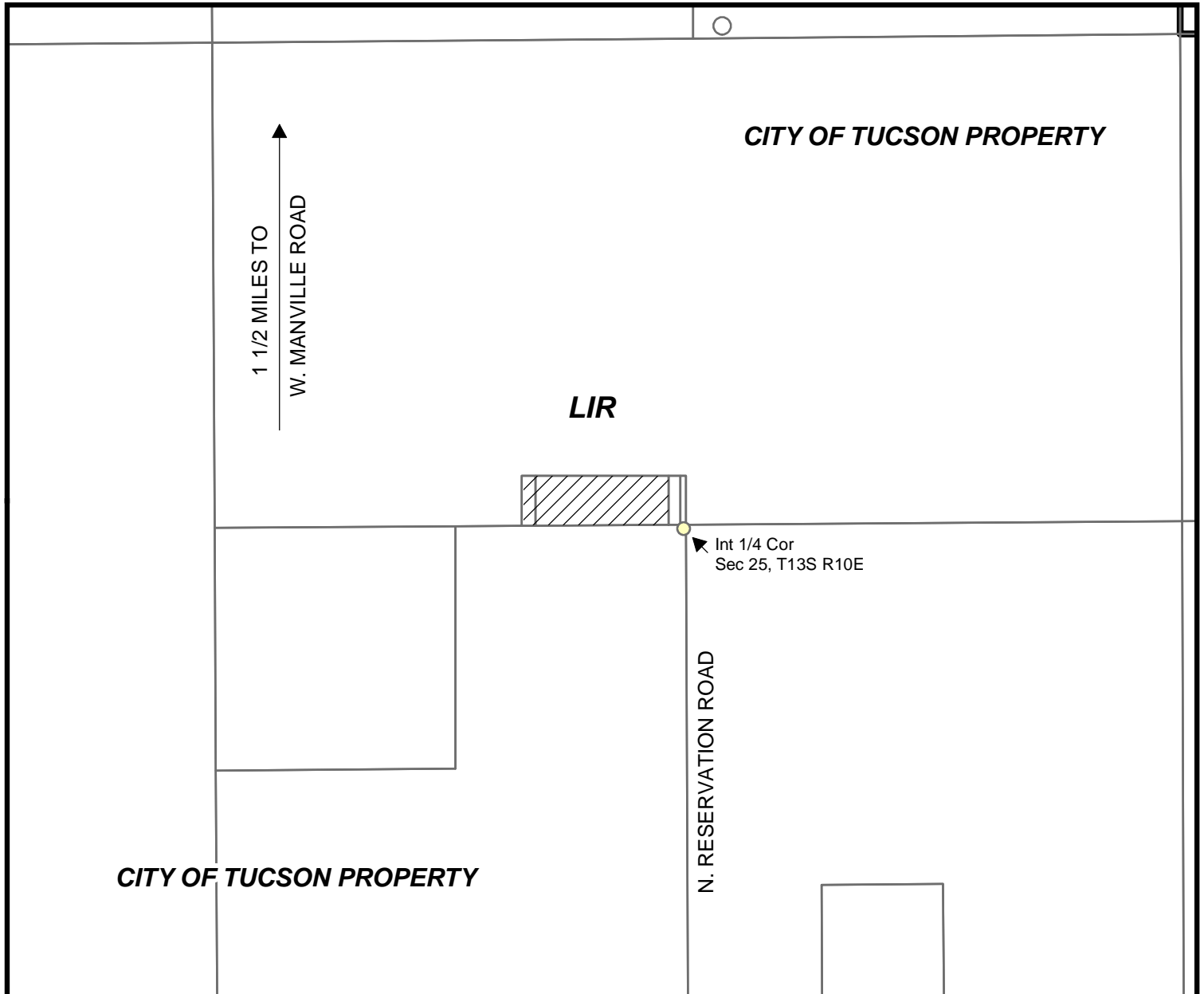
Comprehensive Plan Exhibit



**PIMA COUNTY DEVELOPMENT SERVICES DEPARTMENT
 PLANNING DIVISION**

	Notes:			
	PIMA COUNTY COMPREHENSIVE PLAN CO7-13-10			
	Planning & Zoning Hearing: 4/27/22 (scheduled)	Board of Supervisors Hearing: TBD		
	Base Map(s): 206	Map Scale: 1:10,000	Map Date: 3/27/2022 - ds	

From: [DSD Application for Rezoning or Specific Plan](#)
[DSD Planning](#)
To: Application for Rezoning / Specific Plan Submission
Date: Friday, November 19, 2021 5:01:50 PM
Attachments: [Site Analysis Document - 4G Farms Specific Plan.pdf](#)
[Letter of Authorization Document - owner authorization.pdf](#)

CAUTION: This message and sender come from outside Pima County. If you did not expect this message, proceed with caution. Verify the sender's identity before performing any action, such as clicking on a link or opening an attachment.

New submission

You received a new submission.

Owner name

Chris Bratton

Owner address

3114 E. Taurus Place

Owner city

Chandler

Owner state

AZ

Owner zipcode

85249

Owner phone

5202504515

Email

brattonharvest@gmail.com

Applicant name

Robin Large, Lazarus & Silvyn

Applicant address

5983 E. Grant Rd., Ste. 290

Applicant city

Tucson

Applicant state

AZ

Applicant zipcode

85712

Applicant phone

5202074464

Applicant_email

RLarge@LSLawAZ.com

Property address

3601 N. Reservation Road

Property parcel number

208-45-004A & -005B

Property acreage

5

Property present zone

Rural Homestead (RH)

Property proposed zone

Specific Plan

Policies

Low Intensity Rural (LIR)

Letter of authorization document

[owner_authorization.pdf](#)

Site analysis document

[4G_Farms_Specific_Plan.pdf](#)

Ftp-link

Signature

I confirm the information provided is true and accurate to the best of my knowledge. I am the owner of the above described property or have been authorized by the owner to make this application. (By checking the box, I am electronically signing this application.)

Application date

19-Nov-2021

November 12, 2021

Pima County
Planning & Development Services Department
201 N. Stone Ave.
Tucson, AZ 85701

Re: Property Owner Authorization – 4G Farms Specific Plan

Dear Planning Staff:

I, Christopher Bratton, am the owner of approximately 4.5 acres of real property located on N. Reservation Road, Assessor Parcel Number 208-45-004A (the "Property") within unincorporated Pima County (the "County").

This letter authorizes Lazarus & Silvyn, P.C., Cypress Civil Engineering, Rob Paulus Architects, and their respective employees and other engaged consultants to take such action required to obtain all zoning/development entitlements and related approvals for the Property, including, but not limited to, filing applications for the specific plan, development plan, grading permits and associated building permits.

Sincerely,



Christopher Bratton

Date: _____

11-14-21

November 12, 2021

Pima County
Planning & Development Services Department
201 N. Stone Ave.
Tucson, AZ 85701

Re: Property Owner Authorization – 4G Farms Specific Plan

Dear Planning Staff:

I, Craig Bratton, am the owner of approximately 0.5 acres of real property located on N. Reservation Road, Assessor Parcel Number 208-45-005B (the "Property") within unincorporated Pima County (the "County").

This letter authorizes Lazarus & Silvyn, P.C., Cypress Civil Engineering, Rob Paulus Architects, and their respective employees and other engaged consultants to take such action required to obtain all zoning/development entitlements and related approvals for the Property, including, but not limited to, filing applications for the specific plan, development plan, grading permits and associated building permits.

Sincerely,



Craig Bratton

Date: 11/15/21