



**BOARD OF SUPERVISORS AGENDA ITEM REPORT
CONTRACTS / AWARDS / GRANTS**

Award Contract Grant

Requested Board Meeting Date: June 20, 2017

* = Mandatory, information must be provided

or Procurement Director Award

***Contractor/Vendor Name (DBA):**

City of Tucson

***Project Title/Description:**

Houghton Road Widening: Union Pacific Railroad to Interstate 10 Intergovernmental Agreement

***Purpose:**

The project consists of planning, design, development, and construction activities for roadway improvements to Houghton Road from the Union Pacific Railroad to Interstate 10, specifically a 6 lane desert parkway.

***Procurement Method:**

Non-Procurement Contract as identified in BOS D29.4 - Intergovernmental Agreement

***Program Goals/Predicted Outcomes:**

The project will widen the roadway to 6 lanes in order to accommodate the increase in traffic.

***Public Benefit:**

The traveling public will experience less congestion, increased mobility and overall improved safety.

***Metrics Available to Measure Performance:**

Metrics will consist of tracking project schedule to ensure timely completion.

***Retroactive:**

No

JUN 14 11:00 AM 2017
AR

To: COB- 6-14-17 (3)
Ver. - 1
PJS. -
Addendum

Procure Dept 06/14/17 PM 12:22

Contract / Award Information

Document Type: CT Department Code: TR Contract Number (i.e., 15-123): 17*393

Effective Date: 6/20/2017 Termination Date: 6-19-2012 Prior Contract Number (Synergen/CMS): _____

Expense Amount: \$* 4,900,000.00 Revenue Amount: \$ _____

*Funding Source(s) required: Development Fees \$2,800,000.00
HURF Bonds \$2,100,000.00

Funding from General Fund? Yes No If Yes \$ _____ % _____

Contract is fully or partially funded with Federal Funds? Yes No

*Is the Contract to a vendor or subrecipient? No

Were insurance or indemnity clauses modified? Yes No

If Yes, attach Risk's approval

Vendor is using a Social Security Number? Yes No

If Yes, attach the required form per Administrative Procedure 22-73.

Amendment / Revised Award Information

Document Type: _____ Department Code: _____ Contract Number (i.e., 15-123): _____

Amendment No.: _____ AMS Version No.: _____

Effective Date: _____ New Termination Date: _____

Prior Contract No. (Synergen/CMS): _____

Expense or Revenue Increase Decrease Amount This Amendment: \$ _____

Is there revenue included? Yes No If Yes \$ _____

*Funding Source(s) required:

Funding from General Fund? Yes No If Yes \$ _____ % _____

Grant/Amendment Information (for grants acceptance and awards) Award Amendment

Document Type: _____ Department Code: _____ Grant Number (i.e., 15-123): _____

Effective Date: _____ Termination Date: _____ Amendment Number: _____

Match Amount: \$ _____ Revenue Amount: \$ _____

*All Funding Source(s) required:

*Match funding from General Fund? Yes No If Yes \$ _____ % _____

*Match funding from other sources? Yes No If Yes \$ _____ % _____

*Funding Source: _____

*If Federal funds are received, is funding coming directly from the Federal government or passed through other organization(s)? _____

Contact: Rick Ellis, Deputy Director

Department: Transportation

Telephone: 724-6385

Department Director Signature/Date: [Signature] 6/6/17

Deputy County Administrator Signature/Date: [Signature] 6/6/17

County Administrator Signature/Date: [Signature] 6/9/17

(Required for Board Agenda/Addendum Items)

ADOPTED BY THE
MAYOR AND COUNCIL

May 23, 2017

RESOLUTION NO. 22752

RELATING TO TRANSPORTATION; AUTHORIZING AND APPROVING THE INTERGOVERNMENTAL AGREEMENT (IGA) BETWEEN PIMA COUNTY (COUNTY) AND THE CITY OF TUCSON (CITY) FOR THE HOUGHTON ROAD WIDENING: UNION PACIFIC RAILROAD (UPRR) TO INTERSTATE 10 (I-10); AND DECLARING AN EMERGENCY.

NOW, THEREFORE, BE IT RESOLVED BY THE MAYOR AND COUNCIL OF THE CITY OF TUCSON, ARIZONA, AS FOLLOWS:

SECTION 1. The IGA between the County and the City for the Houghton Road Widening: Union Pacific Railroad to Interstate 10, RTA Roadway Improvement Element #32, attached to this Resolution as Exhibit A, is authorized and approved.

SECTION 2. The Mayor is authorized and directed to execute the aforementioned Exhibit A and any and all documents necessary to effectuate the above contemplated transaction for and on behalf of the City and the City Clerk is authorized and directed to attest to the same.

SECTION 3. The various City officers and employees are authorized and directed to perform all acts necessary or desirable to give effect to this Resolution.

SECTION 4. WHEREAS, it is necessary for the preservation of the peace, health, and safety of the City of Tucson that this Resolution become immediately

effective, an emergency is hereby declared to exist and this Resolution shall be effective immediately upon its passage and adoption.

PASSED, ADOPTED AND APPROVED BY THE MAYOR AND COUNCIL OF
THE CITY OF TUCSON, ARIZONA, May 23, 2017.

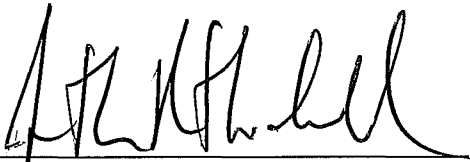

MAYOR

ATTEST:

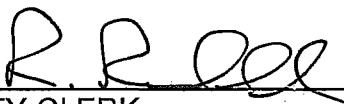

CITY CLERK

APPROVED AS TO FORM:

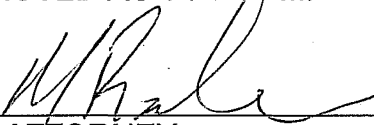

CITY ATTORNEY

REVIEWED BY:

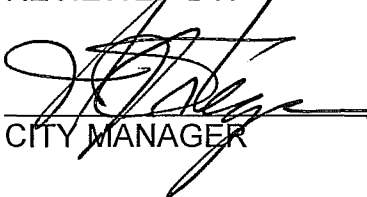

CITY MANAGER

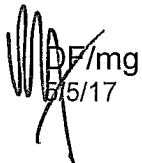
DF/mg
5/5/17

Intergovernmental Agreement
between
Pima County and the City of Tucson
for the
Houghton Road Widening: Union Pacific Railroad to Interstate 10, RTA
Roadway Improvement Element #32

This Intergovernmental Agreement (“Agreement”) is entered into by Pima County, a political subdivision and body politic of the State of Arizona (“County”); and the City of Tucson, a municipal corporation of the State of Arizona (“City”); pursuant to Arizona Revised Statutes section A.R.S. § 11-952. The City and the County are collectively referred to in this Agreement as “the Parties” and either may be individually referred to as a “Party.”

Recitals

- A. The County is authorized by A.R.S. § 11-251(4) and A.R.S. §§ 28-6701 et seq. to lay out, maintain, control, and manage public roads and to establish, construct, alter, and maintain county highways within Pima County.
- B. The City is authorized by A.R.S. § 9-276 to lay out and establish, regulate the use, open, vacate, alter, widen, extend, grade, pave, plant trees or otherwise improve streets, alleys, avenues, sidewalks, parks, public grounds and off-street parking sites and acquire any property necessary or convenient for that purpose by the exercise of the right of eminent domain.
- C. The City and County wish to cooperate in the construction of roadway improvements for the Houghton Road Widening: Union Pacific Railroad to Interstate 10 (“the Project”).
- D. A portion of the Project lies within the jurisdictional limits of the City and a portion lies within unincorporated Pima County.
- E. The City has been identified as the Lead Agency (“Lead Agency”) for the Project and will be responsible for all aspects of project implementation including, but not limited to, planning, project management, risk management, design, construction, service delivery and operation, administration, advertisement, award, execution and administration of the Project.
- F. The City and County find it prudent to enter into this Agreement for the purpose of providing for the County’s contribution of funding for the construction of the Project.
- G. The County intends to contribute \$4,900,000 to the Project under the terms and conditions contained in this Agreement and has entered into this Agreement with the City for that purpose.

H. The County has authority to contribute development fees to the Project under A.R.S § 11-1103, and to contribute Highway User Revenue Fund (HURF) bond funds to the Project under A.R.S. § 11-371.

NOW THEREFORE; the City and the County, pursuant to the above and in consideration of the matters and things thereafter set forth, do mutually agree as follows:

AGREEMENT

1. **Purpose.** The purpose of this Agreement is to set forth the responsibilities of the City and County for the funding and implementation of the Project.
2. **Project.** The Project consists of planning, design, development, and construction activities for roadway improvements to Houghton Road from the Union Pacific Railroad to Interstate 10, specifically a 6-lane desert parkway. The Project is a portion of the larger project identified as Roadway Improvement Element #32 in the RTA's Regional Transportation Plan.
3. **County Contribution.** The County shall pay a maximum of \$4,900,000.00 ("Maximum Contribution"), consisting of \$2,800,000.00 in Development Fees collected under A.R.S. § 11-1102, and an anticipated \$2,100,000.00 in 1997 Highway User Revenue Fund (HURF) Bond funds, to the City in fourteen equal payments of \$350,000.00 as the County's contribution to the Project construction phase. The County's payments shall commence on the first month following award of a construction contract by the City. The County's payments shall be made monthly upon receipt of invoices from the City.

City hereby acknowledges that County bond funds may be limited for City projects in any given fiscal year because actual revenues available to the County do not meet expectations due to a variety of reasons, such as actions of the Arizona Legislature to reduce state shared revenues, increased commodity costs of construction materials or fuels, or general economic conditions.

Subject only to the possible limitations above, the County will use its best efforts to provide County HURF bond funds in accordance with the schedule identified in this section and does not foresee, based upon present conditions, any difficulty in meeting the bond disbursement schedule.

4. **Establishment of County Highway.**
 - a. *Petition to Establish Remaining County Highway.* Pursuant to A.R.S. § 28-6701(B), the Tucson City Council has petitioned the Pima County Board of Supervisors to establish a County highway for the portion of the Project within the City limits, described and depicted in attached **Exhibit A**.

- b. *Establishment of County Highway.* The Pima County Board of Supervisors shall take the actions required by A.R.S. § 28-6702 and § 28-6703 to establish the roadway as a County highway.
- c. *Establishment for Funding Purposes Only.* The establishment of the roadway is solely for the purposes of allowing County to contribute HURF bond funds to the Project, and County at no time will be responsible for any activities associated with design, right of way acquisition, permitting, utility relocation, constructing or maintaining the roadway.
- d. *Abandonment of County Highway Within City.* Upon completion in substantial compliance with drawings and specifications and acceptance of the Project by the City, the County will abandon under A.R.S. § 28-7212 all of the Project roadway lying within the City limits.

5. Permits. The County shall grant the City and its Contractors right of way use permits allowing full accessibility to perform the work as described. These permits shall be granted at no cost to the Project.

6. City Responsibility; Changes; Disputes. As Lead Agency for the Project, the City will have responsibility for Project oversight, including administration of the design and construction contracts. This includes responsibility for verification of quantities, quality of workmanship, contract change orders, and Project modifications as necessary. The City will advertise and start Project construction activities during FY 2019 and thereafter will diligently pursue the Project to completion. The City will exercise due diligence to consult with the County on items and issues as they arise so that the County has ample opportunity to provide input. In the event that there is a disagreement over any Project elements, the issue shall be escalated as appropriate. In the event that the disagreement remains unresolved, the City will retain the final decision making authority.

7. Ownership of Improvements. Upon completion of the Project, ownership of all Project improvements located in the limits of the City of Tucson shall automatically vest in the City, and ownership of all Project improvements in unincorporated Pima County shall automatically vest in the County. Except as the Parties otherwise agree or have agreed to through separate maintenance agreements, each Party shall operate and maintain those Project improvements that it owns.

8. Effective Date and Term

- a. *Effective Date.* This Agreement shall be effective on the date it is signed by the last Party to sign this Agreement.
- b. *Term.* This Agreement shall remain in effect through completion of the Project and completion of all payments required under this Agreement, unless earlier terminated as authorized by this Agreement or by law.

9. Termination.

- a. *For cause.* Either Party may terminate this Agreement for material breach of the Agreement by the other Party. Prior to any termination under this paragraph, the Party allegedly in default shall be given written notice by the other Party of the nature of the alleged default. The Party said to be in default shall have forty-five days to cure the default. If the default is not cured within that time, the other Party may terminate this Agreement. Any such termination shall not relieve a Party from liabilities or costs already incurred under this Agreement.
- b. *A.R.S. § 38-511.* This Agreement may be terminated pursuant to A.R.S. § 38-511 in certain instances involving conflict of interest.
- c. *Arbitrage Rebate Requirements.* The County reserves the right to cease payments to City and unilaterally terminate this Agreement if County determines, in County's sole discretion, that any action or inaction on the part of City is likely to occur that would adversely affect the election made by the County under the Tax Exempt Bond Rules relating to exceptions for arbitrage rebate.
- d. *Bond Limitations.* County may unilaterally terminate this Agreement whenever the County determines violations of federal arbitrage regulations are likely to occur relating to the County's outstanding obligations to manage all bond funds, arbitrage avoidance, and bond debt, as well as County's outstanding responsibilities to other projects outside of the City. City hereby recognizes and agrees that said County responsibilities may limit funds available for City projects in any given fiscal year because of revenues actually available to the County because of unrealized state shared revenues or general economic downturns and may reallocate the Project funds.
- f. *Effect of Termination.* Any termination of this Agreement shall not relieve any party from liabilities or costs already incurred under this Agreement, nor affect any ownership of the Project constructed pursuant to this Agreement.

10. Federal Treasury Regulations. City acknowledges that County manages the expenditures of bond proceeds in order to qualify for a spending exception to the arbitrage rebate requirements of Sections 148 through 150 of the Internal Revenue Code of 1986 and the related regulations found in 26 CFR Part 1, §§1.148 through 1.150 as may be modified from time to time (such statutes and regulations hereinafter referred to as the "Tax Exempt Bond Rules"). City further acknowledges that arbitrage rebate is affected by both the use of bond proceeds and by the timing of bond related expenditures. Notwithstanding any other provision of this Agreement, County may, in County's sole discretion, either (i) reallocate Project funds to other projects funded with County bonds, or (ii) terminate this Agreement if, in County's sole determination, such reallocation or termination is necessary to the County under the Tax Exempt Bond Rules either (a) to qualify for a spending exception to the arbitrage rebate requirements, (b) to reduce the amount of any potential arbitrage rebate or

penalty, or (c) to manage the County's bond proceeds.

11. Indemnification.

- a. *Mutual Indemnity.* To the fullest extent permitted by law, each Party to this Agreement shall indemnify, defend and hold the other Party, its governing boards or bodies, officers, departments, employees and agents, harmless from and against any and all suits, actions, legal or administrative proceedings, claims, demands, liens, losses, fines or penalties, damages, liability, interest, attorney's, consultant's and accountant's fees or costs and expenses of whatsoever kind and nature, resulting from or arising out of any act or omission of the indemnifying party, its agents, employees or anyone acting under its direction or control, whether intentional, negligent, grossly negligent, or amounting to a breach of contract, in connection with or incident to the performance of this Agreement.
- b. *Preexisting conditions.* To the fullest extent permitted by law, each party to this Agreement shall indemnify, defend and hold the other party, its governing board or body, officers, departments, employees and agents, harmless from and against any claims and damages, as fully set out above in Paragraph 11(a), resulting from or arising out of the existence of any substance, material or waste, regulated pursuant to federal, state or local environmental laws, regulations or ordinances, that is present on, in or below or originated from property owned or controlled by the indemnifying party prior to the execution of this Agreement.
- c. *Indemnification for Design.* To the fullest extent permitted by law, when County and City have agreed to use City Design Standards which differ from County standards for any element of the Project, City shall indemnify, defend and hold County, its board of supervisors, officers, departments, employees and agents, harmless from and against any claims and damages, as fully set out above in Paragraph 11(a), resulting from or arising out of the existence of the element, or naming the element as a cause of the harm or injury.
- d. *Notice.* Each Party shall notify the other Party in writing within thirty (30) days of the receipt of any claim, demand, suit or judgment against the receiving Party for which the receiving Party intends to seek indemnification from the other Party pursuant to this paragraph. Each Party shall keep the other Party informed on a current basis of its defense of any claims, demands, suits, or judgments relating to this Agreement.
- e. *Negligence of indemnified Party.* The obligations under this paragraph 11 shall not extend to the negligence of an indemnified Party, its agents or employees.
- f. *Survival of termination.* This paragraph 11 shall survive the termination, cancellation or revocation, whether in whole or in part, of this Agreement.

12. Insurance. When requested by the other party, each party shall provide proof to the other of

its workers' compensation, automobile, accident, property damage, and liability coverage or program of self-insurance.

13. Workers' Compensation. An employee of either party shall be deemed to be an "employee" of both public agencies while performing pursuant to this Agreement, for purposes of A.R.S. § 23-1022 and the Arizona Workers' Compensation laws. The primary employer shall be solely liable for any workers' compensation benefits that may accrue. Each party shall post a notice pursuant to the provisions of A.R.S. § 23- 906 in substantially the following form:

All employees are hereby further notified that they may be required to work under the jurisdiction or control or within the jurisdictional boundaries of another public agency pursuant to an intergovernmental agreement or contract, and under such circumstances they are deemed by the laws of Arizona to be employees of both public agencies for the purposes of workers' compensation.

14. City Accounting of County Project Costs. City shall account for all Project costs to be paid by County pursuant to this Agreement.

15. Legal Jurisdiction. Nothing in this Agreement shall be construed as either limiting or extending the legal jurisdiction of the County or City.

16. No Joint Venture. It is not intended by this Agreement to, and nothing contained in this Agreement shall, be construed to create any partnership, joint venture or employer-employee relationship between County and City. No Party shall be liable for any debts, accounts, obligations nor other liabilities whatsoever of the other Party as a result of this Agreement, including (without limitation) any party's obligation to withhold Social Security and income taxes for itself or its employees.

17. No Third Party Beneficiaries. This Agreement shall not create any right to any person or entity as a third party beneficiary.

18. Compliance with Laws. The Parties shall comply with all applicable federal, state and local laws, rules, regulations, standards and executive orders, without limitation to those designated within this Agreement. The laws and regulations of the State of Arizona shall govern the rights of the Parties, the performance of this Agreement and any disputes hereunder. Any action relating to this Agreement shall be brought in an Arizona court.

a. *Anti-Discrimination.* The provisions of A.R.S. § 41-1463 and Executive Order Number 99-4, as modified by Executive Order Number 2009-9, issued by the Governor of the State of Arizona are incorporated by this reference as a part of this Agreement.

- b. *Americans with Disabilities Act.* This Agreement is subject to all applicable provisions of the Americans with Disabilities Act (Public Law 101-336, 42 U.S.C. §. 12101-12213) and all applicable federal regulations under the Act, including 28 CFR Parts 35 and 36.
- c. *Compliance with County Laws.* City agrees to comply with Pima County Code § 3.06.080, "Coordination with other capital planning of the county and region, and applicability to county bond projects implemented by other agencies" and Pima County Ordinance No. 1997-80, Section VIII, "Implementation of Transportation Projects in Other Jurisdictions," as amended.
- d. *Legal Arizona Workers Act Compliance.* City warrants to County that it will, at all times during the term of this Agreement, comply with all federal immigration laws applicable to the warranting party's employment of its employees, and with the requirements of A.R.S. § 23-214(A) (together, the "State and Federal Immigration Laws"). City further agrees to ensure that each contractor who performs work associated with the Project (i) complies with the State and Federal Immigration Laws, and (ii) ensures that any subcontractor who performs work for the contractor complies with the State and Federal Immigration Laws.

City shall further require that each contractor who performs work on the Project subject to this Agreement advises each subcontractor of City's rights, and the subcontractor's obligations, with respect to this subsection, by including a provision in each subcontract substantially in the following form:

"Subcontractor hereby warrants that it will at all times during the term of this contract comply with all federal immigration laws applicable to subcontractor's employees, and with the requirements of A.R.S. § 23-214(A). Subcontractor further agrees that City may inspect the Subcontractor's books and records to insure that Subcontractor is in compliance with these requirements. Any breach of this paragraph by Subcontractor will be deemed to be a material breach of this contract subjecting Subcontractor to penalties up to and including suspension or termination of this contract."

Any breach of the warranty of compliance with the State and Federal Immigration Laws by City or any City contractor or subcontractor on the Project shall be deemed to be a material breach of this Agreement subjecting City to penalties up to and including suspension or termination of this Agreement. A breach of the warranty of compliance with State and Federal Immigration Laws shall further make City liable to County for any additional costs attributable directly or indirectly to remedial action under this subsection.

County may, at any time, inspect City's books and records in order to verify City's compliance with the State and Federal Immigration Laws.

19. Force Majeure. A Party shall not be in default under this Agreement if it does not fulfill any

of its obligations under this Agreement because it is prevented or delayed in doing so by reason of uncontrollable forces. The term uncontrollable forces shall mean, for the purpose of this Agreement, any cause beyond the control of the Party affected, including but not limited to floods, earthquakes, acts of God, or orders of any regulatory government officer or court (excluding orders promulgated by the Party itself), which, by exercise of due diligence and foresight, such Party could not reasonably have been expected to avoid. A Party rendered unable to fulfill any obligations by reason of uncontrollable forces shall exercise due diligence to remove such inability with all reasonable dispatch.

20. Waiver. Waiver by either Party of any breach of any term, covenant or condition herein contained shall not be deemed a waiver of any other term, covenant or condition, or any subsequent breach of the same or any other term, covenant, or condition herein contained.

21. Books and Records. Each Party shall keep and maintain proper and complete books, records and accounts, which shall be open for inspection and audit by duly authorized representatives of the other Party at all reasonable times. Within six months after acceptance of the Project by the City and County, the County shall provide, at no cost to the City, copies of As-Built drawings of the Project.

22. Inspection and Audit of Records. The appropriate designated representatives of a Party may perform any inspection of the Project or reasonable audit of any books or records of the other Party to satisfy itself that the monies on the Project have been spent and the Project operated and maintained in accordance with this Agreement.

23. Construction of Agreement.

- a. *Entire Agreement.* This instrument constitutes the entire agreement between the parties pertaining to the subject matter hereof, and all prior or contemporaneous agreements and understandings, oral or written, are hereby superseded and merged herein.
- b. *Amendment.* This Agreement shall not be modified, amended, altered or changed except by written agreement signed by both parties.
- c. *Construction and Interpretation.* All provisions of this Agreement shall be construed to be consistent with the intention of the parties as expressed in the recitals hereof.
- d. *Captions and Headings.* The headings used in this Agreement are for convenience only and are not intended to affect the meaning of any provision of this Agreement.
- e. *Severability.* In the event that any provision of this Agreement or the application thereof is declared invalid or void by statute or judicial decision, such action shall have no effect on other provisions and their application which can be given effect without the invalid or void provision or application, and to this extent the provisions of this Agreement are severable. In the event that any provision of this Agreement is

declared invalid or void, the parties agree to meet promptly upon request of the other party in an attempt to reach an agreement on a substitute provision.

24. Notification. All notices or demands upon a Party to this Agreement shall be in writing, unless other forms are specifically authorized by this Agreement, and shall be delivered in person or sent by mail addressed as follows:

City of Tucson:

Daryl W. Cole, Director
Department of Transportation
201 N. Stone Ave., 6th Floor
Tucson, Arizona 85701

Pima County:

Priscilla S. Cornelio, P.E., Director
Pima County Department of Transportation
201 N. Stone, 4th Floor
Tucson, Arizona 85701

Notices shall be deemed delivered and received on the date of delivery, if delivered in person, or on the third business day after mailing, if delivered by any form of mail.

Any party may, by written notice to the other parties, designate another address or person for receipt of notices under this Agreement.

REMAINDER OF THIS SECTION INTENTIONALLY LEFT BLANK

In Witness Whereof, County has caused this Agreement to be executed by the Chair of its Board of Supervisors, attested to by the Clerk of the Board, and the City has caused this Agreement to be executed by the Mayor upon resolution of the Mayor and Council and attested to by its Clerk.

PIMA COUNTY:

CITY OF TUCSON:

Sharon Bronson, Chair
Board of Supervisors

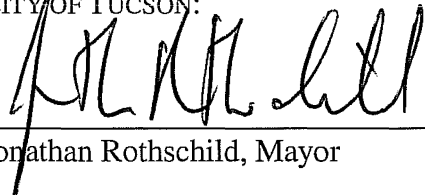

Jonathan Rothschild, Mayor

Date

May 23, 2017

Date

ATTEST:

ATTEST:

Clerk of the Board



City Clerk May 23, 2017

Intergovernmental Agreement Determination

The foregoing Intergovernmental Agreement between Pima County and the City of Tucson has been reviewed pursuant to A.R.S. § 11-952 by the undersigned, who have determined that it is in proper form and is within the powers and authority granted under the laws of the State of Arizona to those parties to the Intergovernmental Agreement represented by the undersigned.

PIMA COUNTY:

CITY OF TUCSON:

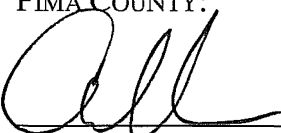

Deputy County Attorney



City Attorney

ANDREW FLAGG

PETITION FOR ESTABLISHMENT OF COUNTY HIGHWAY

TO: The Board of Supervisors of Pima County, Arizona:

The City of Tucson, by and through its Mayor and Council, respectfully petitions that, pursuant to A.R.S. § 28-6701(B), the Board of Supervisors establish and declare as a County Highway the roads described in the attached Exhibit A.

Dated this 23 day of May, 2017

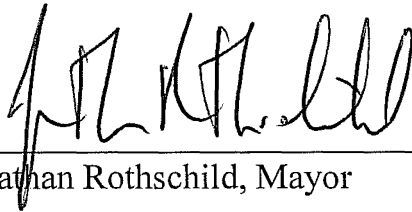

Jonathan Rothschild, Mayor

ATTEST:



City Clerk

EXHIBIT 'A'

HOUGHTON ROAD RIGHT-OF-WAY:
1,026 FEET NORTH OF SECTION CORNER to INTERSTATE-10

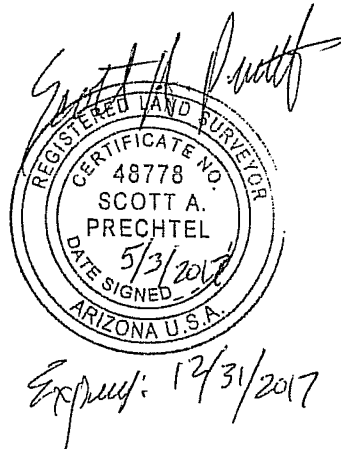
HOUGHTON ROAD, as shown as existing right-of-way on the City of Tucson City Engineer's Plan No. H-2015-003, also being known as RECORD OF SURVEY & RIGHT-OF-WAY PLAN HOUGHTON ROAD UNION PACIFIC RAILROAD to INTERSTATE-10 (Project Number SR1G), on file in Maps and Records in the Office of said City Engineer, from 1,026 feet northerly of the southernmost Section Corner common to Sections 35 & 36, T15S, R15E, to the intersection with the northerly right-of-way of Interstate-10, as depicted in ADOT drawing No. D-10-T-394, and lying within Section 1, T16S, R15E and Sections 35 & 36, T15S, R15E, Gila and Salt River Meridian, Pima County, Arizona.

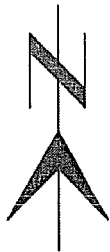



NO SCALE

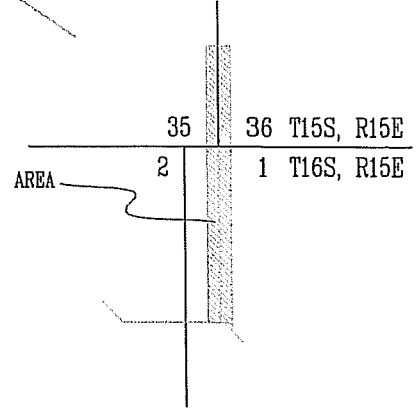
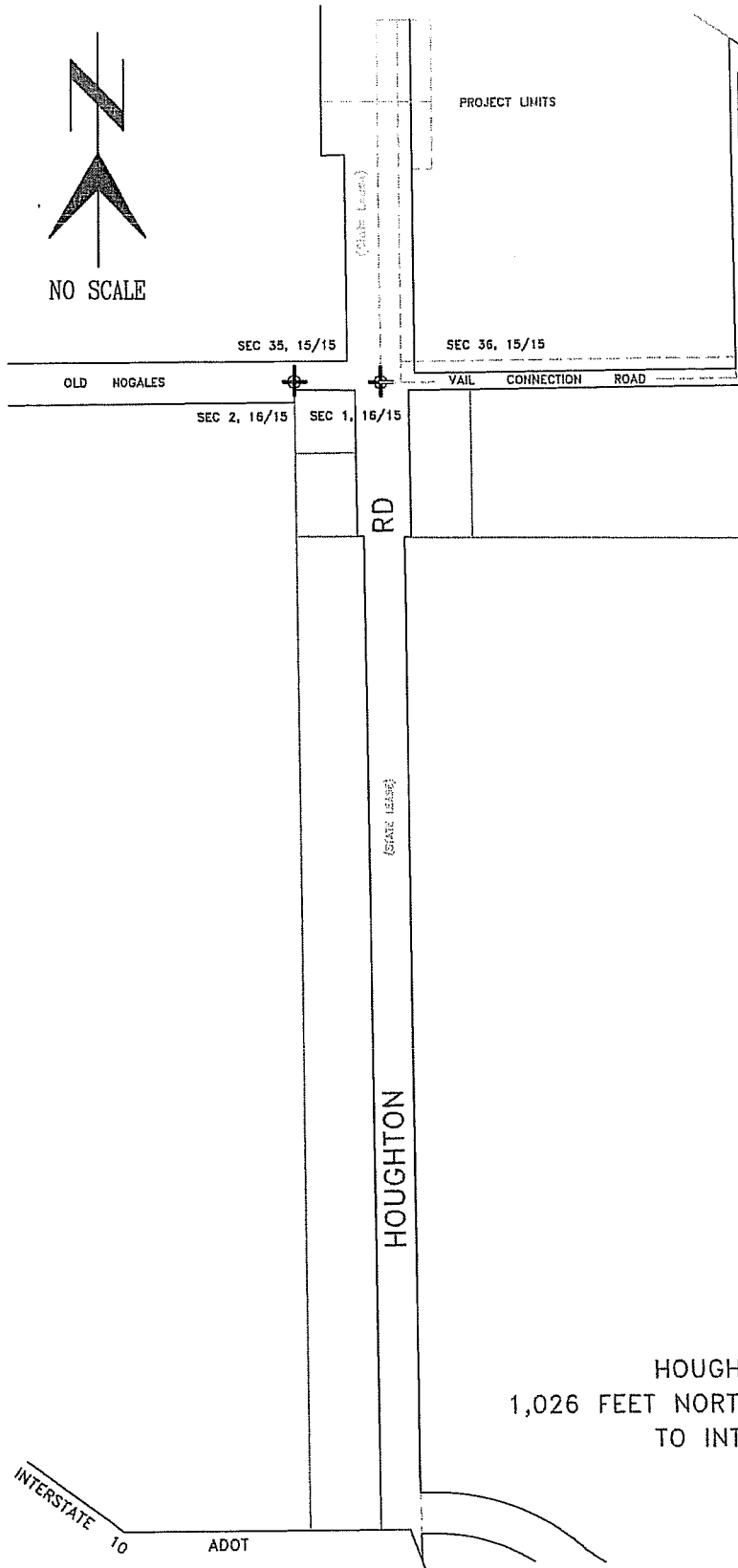

SITE MAP
 SEC 35 & 36, T15S, R15E
 SEC 1, T16S, R15E
 G&SRM, PIMA CO, ARIZONA

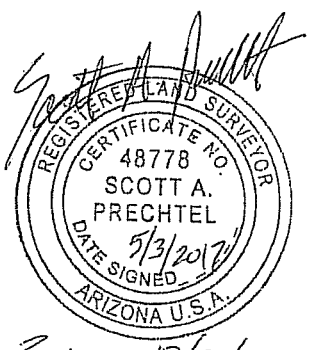

Exp. = 12/31/2017

HOUGHTON ROAD:
 1,026 FEET NORTH OF SECTION CORNER
 TO INTERSTATE-10

Drawn: SAP MAY, 2017
 Scale: NO SCALE
 Approved: _____
 City Engineer

HOUGHTON ROAD
 SECs 35 & 36, T15S, R15E
 & SECTION 1, T16S, R15E

City of Tucson, Arizona
 ENGINEERING DIVISION 
 PLAN # S-2017-004

C:\Jobs\Houghton Exchange.dwg